

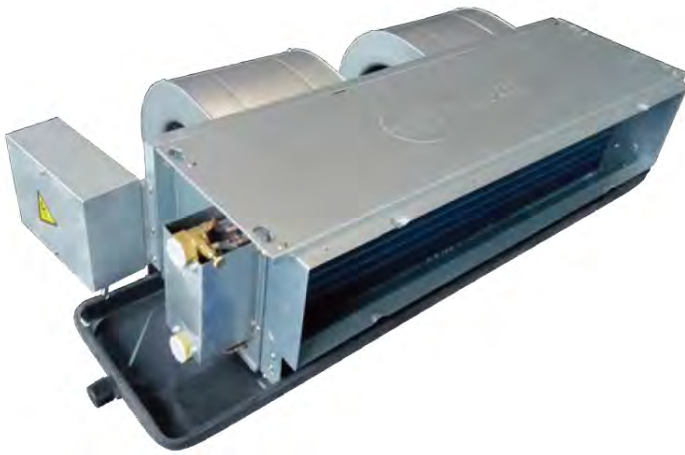

Product Catalog

DCHC/DCHX

Horizontal Series Chilled Water Fan Coil with DCBL Motor
Airflow: 180~2380 m³/h



Product Features

DCHC, with premium comfort and energy efficiency, is the latest generation of DCBL fan coil product developed by Trane Company. The product uses the latest DCBL motor stepless speed control technology, PI temperature control methodology, high efficiency low sound and vibration fan technology, and high efficiency heat exchanger with small diameter tube technology, to achieve quiet, comfort, energy saving, environmental friendly, safe and reliable, etc. benefits.

Rich Offerings

10 unit sizes, airflow range 180~2380CMH, able to meet various building size capacity requirements. Multiple ESP's, 12Pa/30Pa/50Pa/62Pa/75Pa/88Pa/100Pa/112Pa, able to meet jobsite various duct system resistance requirements.

EarthWise Coil (Option)

Offer 3 rows, 4 rows and 3+1 rows EarthWise coil options, dedicated for high delta-T system application to optimize overall system performance.

High Efficiency Coil

Coil is designed with multi-row small diameter copper tubes, together with high efficiency louver fin with hydrophilic coating, the optimum heat exchange efficiency is achieved, in the mean time the condensation carryover is prevented and the anti-corrosion capability is improved. Coil is also designed with counter-flow circuitry, thus the heat exchange efficiency is maximized.

Low Noise Fan

Large diameter forward-curve multi-blade centrifugal fan, with the fan wheel statically and dynamically balanced, to ensure stable and quiet operation, as well as even airflow distribution. Fan wheel hub with isolation, to minimize the shocking load from unit start-up and varying load, thus reducing unit vibration and noise level.

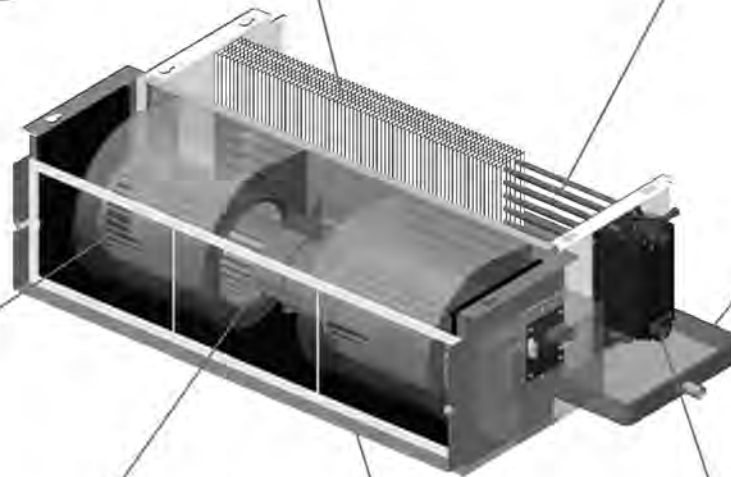

Condensation-Free

One-piece stamping integral type drain pan, without any seam or joint, eliminating leakage or condensation risk. Drain pan is externally lined with one-piece integral type insulation, without any patch or screw attachment, good insulation and aesthetic appearance, while eliminating condensation or corrosion risk. Drain pan is internally designed with different height bracket at each end, to ensure drain pan with a positive slope angle after unit installation, thus guarantee condensate water drained out freely.

Brushless DC Motor

Every unit is equipped with standard DCBL motor, which is Trane newly designed high efficiency brushless DC motor, capable of true stepless fan speed control (1rpm increment). Compared with traditional AC motors, average energy consumption at high speed could be reduced by more than 40%. Motor with IP42 protection grade and class B insulation, thus ensuring high motor reliability and a long service life.

Quiet Structure

Unit casing structure is well engineered with optimum airflow tunnel design, as well as multiple casing sheet metal parts are lined with insulation having good thermal resistance and sound attenuation, to ensure smooth airflow and low unit sound.

Easy Maintenance

Return air plenum is Trane patented design. With no need to remove the whole return air plenum, the fan-motor subassembly could be easily disassembled from the unit, to ease of fan and motor maintenance, as well as coil cleaning.

Easy Installation

Coil water inlet and outlet headers are designed as hexagon shape, to ease of using wrench from multiple angles, convenient for water pipe connection, thus reducing installation time and labor cost.

Smart Control

Every unit is equipped with TM smart thermostat, which uses PI temperature control methodology, able to realize fast cooling or heating at beginning, and precise temperature control (within $\pm 0.5^{\circ}\text{C}$) at stable condition. Thermostat casing is Trane patented design with aesthetic appearance, and has multiple color choices to perfectly fit in the indoor decoration.



Valve Package (Option)

Unit can be optionally equipped with 2-way or 3-way water valve package. Water valve body and actuator are split design, thus convenient for installation, maintenance and replacement.



Product Benefits

Efficient

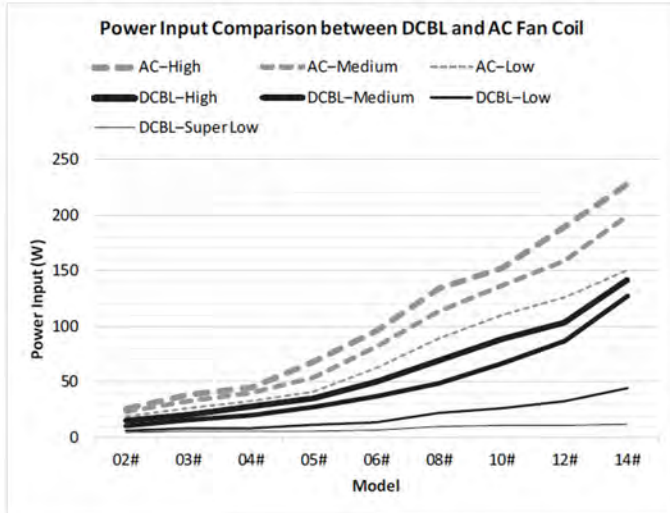

Traditional AC PSC motor efficiency is only about 40%, while DCBL motor efficiency can be above 70%.

DCBL fan coil power consumption is significantly reduced comparing to AC fan coil. Average power consumption could be reduced by more than 40% at high and medium speed, and up to 70% reduction at low speed. DCBL fan coil power consumption at high speed is even lower than AC fan coil at low speed.

DCBL motor has a very wide range of speed operation, thus able to maximize the benefit of energy saving. For example, when the room load is low during night operation or transition season, at auto fan speed mode, DCBL motor could run slowly to super low speed, the unit power consumption is as low as only a few watts.

Quiet

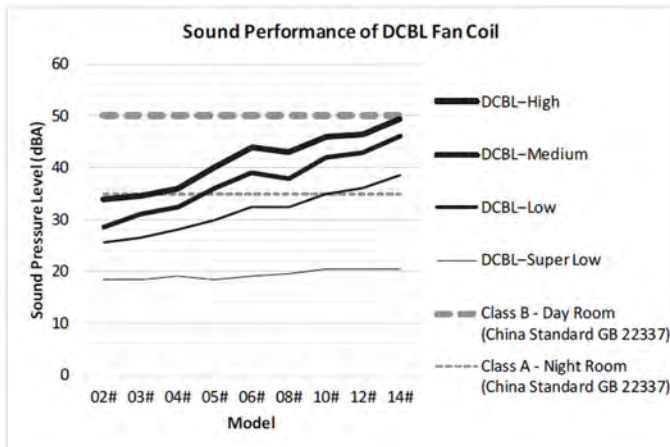

Note: Refer to China Standard GB 22337, Emission Standard for Community Noise:

Class A room is mainly used for sleep, needs to be quiet at night, including residential bedroom, hospital ward, hotel room, etc.

Class B room is mainly used in the day, for thinking and concentration, or for normal speech without interference, including school classroom, conference room, office, non-bedroom residential room, etc.

With large diameter wheel, and wheel hub with rubber isolation design, the unit vibration and noise levels are minimized.

With permanent magnet rotor DCBL motor and without hall sensor, the carbon brush noise from traditional DC motor is avoided.

With ultra high frequency sine wave PWM signal, which is beyond human ear perception, to control motor, very smooth motor running is achieved, and average unit noise level is reduced by 1 dBA comparing to AC motor fan coil.

DCBL motor has a very wide range of speed operation, thus able to maximize the benefit of quiet operation. For example, when the room load is low during night operation or transition season, at auto fan speed mode, DCBL motor could run slowly to super low speed, the unit noise level is as low as 20 dBA.

Comfort

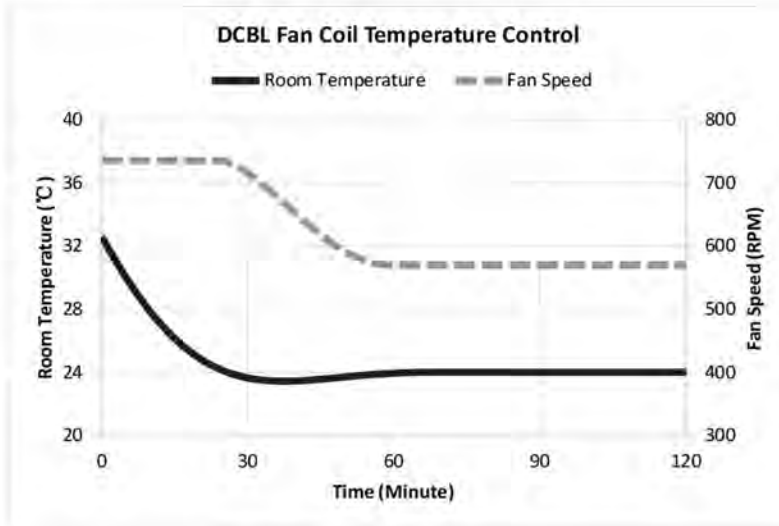

With the DCBL motor controlled by sine-wave PWM signal, fan speed regulating precision can reach 1 RPM.

With PI temperature control methodology, together with stepless fan speed control, fast cooling or heating can be realized to make indoor environment comfortable at a very short period, as well as the room temperature can be precisely controlled within $\pm 0.5^{\circ}\text{C}$ at stable condition.

Smart



Big LCD screen thermostat, classic appearance, suitable for noble and elegant decoration. Thermostat casing even has multiple color choices to perfectly fit in the indoor decoration.

With powerful functions, smart control and convenient operation, thermostat can realize:

- Room temperature setting and display.
- Cooling, heating, ventilation and auto mode.
- High, medium and low fan speed mode, as well as auto fan speed (stepless control).
- Water valve control.
- Real-time display.
- Timer switch (auto power on/off).
- Sleep mode:
 - (Under cooling mode, the setting temperature will automatically increase 1 degree after 3 hours, increase extra 1 degree after 6 hours, and reset to original setting temperature after 10 hours. Under heating mode, the setting temperature will automatically decrease 1 degree after 3 hours, decrease extra 1 degree after 6 hours, and reset to original setting temperature after 10 hours.)
- Memory function for power-down protection.
- Failure display.
- Anti-freeze protection.
- Key Card Function.
- External temperature sensor (optional).

The thermostat along with every unit has been factory set with unit model and ESP type, which could also be set by key combinations in the jobsite, thus more convenient operation.

Network type thermostat is equipped with RS485 port supporting standard Modbus communication protocol, not only can network with group controller to realize zone central control, but also can network with building automation system (BAS) to realize remote monitor and control.



Model Number Descriptions

DCHC Horizontal Concealed DC FCU

D C H C O 2 L 3 O 1 1 0 B 0 A 0 1 A
 -
 1 2 3 4 5 6 7 8 9 10 11 12 13 14 15 16 17 18

Digit 1-4: Model Name
 DCHC = DCBL Fan Coil Horizontal Concealed Unit

Digit 5-6: Size / Nominal Airflow
 02 = 340 CMH 07 = 1190 CMH
 03 = 510 CMH 08 = 1360 CMH
 04 = 680 CMH 10 = 1700 CMH
 05 = 850 CMH 12 = 2040 CMH
 06 = 1020 CMH 14 = 2380 CMH

Digit 7: Connection Side
 L = Left Connection R = Right Connection

Digit 8: Coil Rows and Applications
 2 = 2 Rows (Normal Application, Size O2 ~ O8)
 3 = 3 Rows (Normal Application)
 4 = 4 Rows (Normal Application)
 A = 2 + 1 Rows (Normal Application, Size O2 ~ O8)
 B = 3 + 1 Rows (Normal Application)
 C = 3 Rows (EarthWise Application)
 D = 4 Rows (EarthWise Application)
 E = 3 + 1 Rows (EarthWise Application)
 H = 3 rows hi-capacity (EarthWise)
 6 = 2 rows, [2.5MPa]
 7 = 3 rows, [2.5MPa]
 8 = 4 rows, [2.5MPa]
 P = 2 + 1 rows, [2.5MPa]
 Q = 3 + 1 rows, [2.5MPa]
 R = 3 rows (EarthWise), [2.5MPa]
 S = 4 rows (EarthWise), [2.5MPa]
 T = 3 + 1 rows (EarthWise), [2.5MPa]
 W = 3 rows hi-capacity (EarthWise), [2.5MPa]

Digit 9: Electric Heater
 0 = No Electric Heater
 1 = Electric Heater (w/ Relay in Terminal Box)

Digit 10: Motor Type
 1 = DCBL Motor - ESP 12Pa
 3 = DCBL Motor - ESP 30Pa
 5 = DCBL Motor - ESP 50Pa
 A = DCBL Motor - HESP 100Pa

Digit 11: Voltage/Hz/Phase
 1 = 220 ~ 240VAC/50Hz/1Ph
 2 = 220 ~ 240VAC/60Hz/1Ph

Digit 12: Valve Package
 0 = None
 A = 2-Pipe, 2-way On-Off Valve (Factory Mounted)
 B = 2-Pipe, 3-way On-Off Valve (Factory Mounted)
 C = 4-Pipe, 2-way On-Off Valve (Factory Mounted)

Digit 13: Thermostat
 N = DCBL Network Thermostat (TM83)
 G = DCBL Network Thermostat (TM83), w/ 8m wire
 0 = No Thermostat, for 1 DCBL Thermostat to Control 2 Units (Size O2 ~ O6)
 L = Three-Speed Module, w/ AC LCD Thermostat (White, TM-B10W)
 T = Three-Speed Module, Support 3-Speed Control
 V = Variable-Speed Module, Support 0-10V Control
 5 = LCD network Thermostat, (Black, TM-B20B)
 6 = LCD network Thermostat, (White, TM-B20W)

Digit 14: Plenum Filter
 0 = None
 A = Rear Return Air Plenum
 B = Rear Return Air Plenum w/ 6mm Nylon Filter
 C = Rear Return Air Plenum w/20mm AI Filter
 D = Bottom Return Air Plenum
 E = Bottom Return Air Plenum w/6mm Nylon Filter
 F = Bottom Return Air Plenum w/20mm AI Filter
 G = Rear Return Air Plenum w/ Plug in PCO
 H = Rear Return Air Plenum w/ Plug in PCO w/20mm AI Filter
 J = Bottom Return Air Plenum w/ Plug in PCO
 K = Bottom Return Air Plenum w/ Plug in PCO w/20mm AI Filter
 L = Rear Return Air Plenum w/PM2.5 Filter
 M = Rear Return Air Plenum w/Carbon Filter
 N = Bottom Return Air Plenum w/PM2.5 Filter
 P = Bottom Return Air Plenum w/Carbon Filter
 X = None, 1.0mm GI Casing

Digit 15: Drain Pan
 A = Cold-roll Steel, PE Insulation
 B = Cold-roll Steel, PE Insulation, + 200mm
 C = Cold-roll Steel, PE Insulation, + 310mm
 D = Stainless Steel, PE Insulation
 E = Stainless Steel, PE Insulation, + 200mm
 F = Stainless Steel, PE Insulation, + 310mm
 G = Cold-roll Steel, Non-flammable Insulation
 H = Cold-roll Steel, Non-flammable Insulation, + 200mm
 J = Cold-roll Steel, Non-flammable Insulation, + 310mm
 K = Stainless Steel, Non-flammable Insulation
 L = Stainless Steel, Non-flammable Insulation, + 200mm
 M = Stainless Steel, Non-flammable Insulation, + 310mm
 N = Option A, + Auxiliary Drain Pan
 P = Option B, + Auxiliary Drain Pan
 Q = Option C, + Auxiliary Drain Pan
 R = Option D, + Auxiliary Drain Pan
 S = Option E, + Auxiliary Drain Pan
 T = Option F, + Auxiliary Drain Pan
 U = Option G, + Auxiliary Drain Pan
 V = Option H, + Auxiliary Drain Pan
 W = Option J, + Auxiliary Drain Pan
 X = Option K, + Auxiliary Drain Pan
 Y = Option L, + Auxiliary Drain Pan
 Z = Option M, + Auxiliary Drain Pan
 1 = Cold-roll Steel w/25mm Non-Flame Insulation
 2 = Cold-roll Steel w/25mm Non-Flame Insulation/ 200mm Ext.
 3 = Cold-roll Steel w/25mm Non-Flame Insulation/ 310 mm Ext.
 4 = Stainless Steel w/25mm Non-Flame Insulation
 5 = Stainless Steel w/25mm Non-Flame Insulation/ 200mm Ext.
 6 = Stainless Steel w/25mm Non-Flame Insulation/ 310 mm Ext.

Digit 16: Business Stream
 0=Applied

Digit 17: Design Version
 1 = Frist Design

Digit 18: Region
 A = API
 B = MEA
 C = LAR
 H = HongKong



DCHX Horizontal Exposed DC FCU

D C H X 0 3 L 3 0 1 1 0 N A A 0 1 A
 — — — — — — — — — — — — — — — — — —
 1 2 3 4 5 6 7 8 9 10 11 12 13 14 15 16 17 18

Digit 1-4: DCHX = Fan Coil Horizontal Exposed Unit

Digit 5-6: Size / Nominal Airflow

02 = 340 CMH	07 = 1190 CMH
03 = 510 CMH	08 = 1360 CMH
04 = 680 CMH	10 = 1700 CMH
05 = 850 CMH	12 = 2040 CMH
06 = 1020 CMH	14 = 2380 CMH

Digit 7: Connection Side

L = Left Hand Connection
 R = Right Hand Connection

Digit 8: Coil Rows

3 = 3 Rows Cooling
 C = 3 Rows (EarthWise)
 H = 3 Rows hi-capacity (EarthWise)
 7 = 3 Rows Cooling, [2.5MPa]
 R = 3 Rows (EarthWise), [2.5MPa]
 W = 3 Rows hi-capacity (EarthWise), [2.5MPa]

Digit 9: Electric Heater

0 = No Electric Heater
 1 = With Electric Heater (w/ Relay in Terminal Box)

Digit 10: Motor Type

1 = Motor - ESP 0 Pa

Digit 11: Voltage/Hertz/Phase

1 = 220 - 240/50/1
 2 = 220 - 240/60/1

Digit 12: Valve Package

0 = None

Digit 13: Thermostat

N = DCBL Network Thermostat (TM83)
 0 = No Thermostat, for 1 DCBL Thermostat to Control 2 Units (Size 02 - 06)
 T = Three-Speed Module, Support 3-Speed Control
 V = Variable-Speed Module, Support 0-10V Control
 5 = LCD network Thermostat, (Black, TM-B20B)
 6 = LCD network Thermostat, (White, TM-B20W)

Digit 14: Plenum Filter

A = Rear Return Air Plenum
 B = Rear Return Air Plenum w/ 6mm Nylon Filter
 C = Rear Return Air Plenum w/20mm AI
 G = Rear Return Air Plenum w/Plug in PCO
 H = Rear Return Air Plenum w/Plug in PCO w/20mm AI Filter

Digit 15: Drain Pan

A = Cold-roll Steel w/PE Insulation
 D = Stainless Steel w/PE Insulation
 G = Cold-roll Steel, Non-flammable Insulation

Digit 16: Business Stream

0=Applied

Digit 17: Design Version

1 = Frist Design

Digit 18: Region

A = APR
 B = MAIR
 C = LAR
 H = HongKong



Performance Data

3 Rows Unit (2-Pipe)

Unit Size			DCHC02	DCHC03	DCHC04	DCHC05	DCHC06	DCHC07	DCHC08	DCHC10	DCHC12	DCHC14	
Airflow	m ³ /h	High	340	510	680	850	1020	1190	1360	1700	2040	2380	
		Medium	280	410	550	690	830	970	1100	1360	1630	1900	
		Low	180	270	350	440	520	610	690	860	1020	1190	
Normal Application	Cooling Capacity	kW	High	2.21	3.16	4.17	5.06	6.10	7.00	8.00	9.30	11.10	13.00
	Heating Capacity	kW	High	3.50	5.20	6.70	8.12	9.70	11.35	13.00	15.50	18.00	20.80
	Water Flow Rate	l/s	High	0.11	0.15	0.20	0.25	0.30	0.34	0.39	0.45	0.53	0.63
	Water Pressure Drop	kPa	High	25	24	25	30	40	33	35	35	40	50
EarthWise Application	Cooling Capacity	kW	High	2.21	3.14	3.99	5.02	6.10	7.20	7.98	9.85	11.31	13.29
	Heating Capacity	kW	High	3.37	4.84	6.32	7.56	9.16	11.00	12.27	14.92	17.15	19.95
	Water Flow Rate	l/s	High	0.07	0.10	0.12	0.16	0.20	0.21	0.24	0.29	0.34	0.40
	Water Pressure Drop	kPa	High	29	22	17	29	40	34	33	36	35	50
High Capacity EarthWise Application	Cooling Capacity	kW	Medium	-	2.06	2.70	3.39	4.20	4.6	5.41	6.53	7.49	8.87
	Heating Capacity	kW	Medium	-	3.61	4.73	5.93	7.35	10.80	9.47	11.43	13.11	15.52
	Water Flow Rate	l/s	Medium	-	0.06	0.08	0.11	0.12	0.13	0.16	0.19	0.22	0.27
	Water Pressure Drop	kPa	Medium	-	28	20	30	22	30	40	35	35	48
Electric Heater Heating Capacity		kW	High	0.50	1.00	1.40	1.60	1.80	2.30	2.80	3.20	3.60	4.60
Power Input	12Pa	W	High	15	21	28	35	50	59	69	89	103	142
			Medium	11	16	20	28	37	42	48.5	66.5	87	127
			Low	6.5	8	9	12	14	20	22.5	26	32.5	45
			Super Low	4	4.5	4.5	5	5.5	8	9	9.5	10	10.5
	30Pa	W	High	20	30	37	47	63	67	84	106	122	167
			Medium	16.5	23.5	32	39.5	51	57	70.5	85.5	107.5	146.5
			Low	9	12.5	15.5	19	20	24	29.5	37	41.5	52
			Super Low	4	4.5	4.5	5	5.5	8	9	9.5	10	10.5
	50Pa	W	High	28	42	50	60	77	87	103	127	156	200
			Medium	22.5	33	45	52.5	60.5	73	85.5	113	130	172.5
			Low	12.5	17	23.5	27	29	36	42	56	59	70.5
			Super Low	4	4.5	4.5	5	5.5	8	9	9.5	10	10.5
Sound Pressure Level	12Pa	dBA	High	34	34.5	36	40	44	43	43	46	46.5	49.5
			Medium	28.5	31	32.5	36	39	38	38	42	43	46
			Low	25.5	26.5	28	30	32.5	32	32.5	35	36	38.5
			Super Low	18.5	18.5	19	18.5	19	19.5	19.5	20.5	20.5	20.5
	30Pa	dBA	High	38	38.5	40.5	43	45.5	43	45.5	48.5	49.5	51
			Medium	32.5	36.5	38.5	40	43.5	41.5	43	45.5	46.5	48.5
			Low	30.5	34	35.5	38	39	39	39	43	44	46
			Super Low	19	18.5	18.5	19	18.5	19	19	20.5	21	21
	50Pa	dBA	High	41	42	44	45	46.5	45	48	50.5	51	53
			Medium	35	38.5	40	43	42.5	43.5	46	48	48	50.5
			Low	33.5	37	38.5	41	40.5	41.5	43.5	46	45.5	47.5
			Super Low	18.5	18	17.5	19	18.5	19	19	20	20	20.5
Net Weight	Without Plenum		kg	12	15	16.5	17.5	20.5	27	29	32	35.5	38
	With Rear Plenum		kg	15	18.5	20.5	22	25.5	33	35	39	43	46
	With Bottom Plenum		kg	15.5	19	21	22.5	26	33.5	35.5	39.5	43.5	47
Fan	Type	Forward-Curve Multi-Blades Centrifugal Fan											
	Quantity	1	2	2	2	2	3	3	4	4	4	4	
Motor	Type	Brushless DC Motor											
	Protection Grade	IP42											
	Insulation Class	Class B											
	Quantity	1	1	1	1	1	2	2	2	2	2	2	
Coil	Type	Copper Tube / Hydrophilic Aluminum Fin											
	Working Pressure	1.8 MPa											
Connection	Water Inlet/Outlet	Rc 3/4" (Female)											
	Condensate Outlet	R 3/4" (Male)											
Options			Return Air Plenum, Filter, Valve, Thermostat, Various Drain Pans										

- Notes:**
- Airflow, cooling and heating capacities, etc. are performance data of bare unit (i.e. without return air plenum).
 - Normal Application:
 - Cooling: inlet air dry/wet bulb temperature: 27/19.5°C; chilled water inlet/outlet temperature: 7/12°C.
 - Heating: inlet air dry bulb temperature: 21°C; hot water inlet temperature: 60°C; same water flow rate as cooling.
 - EarthWise Application:
 - Cooling: inlet air dry/wet bulb temperature: 27/19.5°C; chilled water inlet/outlet temperature: 5/13°C.
 - Heating: inlet air dry bulb temperature: 21°C; hot water inlet temperature: 60°C; same water flow rate as cooling.
 - High Capacity EarthWise Application:
 - Cooling: inlet air dry/wet bulb temperature: 26.7/19.4°C; chilled water inlet/outlet temperature: 7.2/15.6°C.
 - Heating: inlet air dry bulb temperature: 21°C; hot water inlet temperature: 60°C; same water flow rate as cooling.
 - Sound pressure data are bare unit (i.e. without return air plenum) tested in semi-anechoic room according to China standard GB/T 19232.

2 Rows Unit (2-Pipe)

Unit Size			DCHC02	DCHC03	DCHC04	DCHC05	DCHC06	DCHC07	DCHC08	
Airflow	m ³ /h	High	350	520	690	870	1040	1210	1380	
		Medium	280	410	550	700	830	970	1100	
		Low	180	270	350	450	520	610	690	
Normal Application	Cooling Capacity	kW	High	1.90	2.80	3.60	4.50	5.40	6.30	7.20
	Heating Capacity	kW	High	3.15	4.93	6.10	7.41	8.90	11.00	12.00
	Water Flow Rate	l/s	High	0.10	0.14	0.17	0.21	0.26	0.31	0.34
	Water Pressure Drop	kPa	High	15	30	25	30	34	40	36
Electric Heater Heating Capacity		kW	High	0.50	1.00	1.40	1.60	1.80	2.30	2.80
Power Input	12Pa	W	High	15	21	28	35	50	59	69
			Medium	11	16	20	28	37	42	48.5
			Low	6.5	8	9	12	14	20	22.5
			Super Low	4	4.5	4.5	5	5.5	8	9
	30Pa	W	High	20	30	37	47	63	67	84
			Medium	16.5	23.5	32	39.5	51	57	70.5
			Low	9	12.5	15.5	19	20	24	29.5
			Super Low	4	4.5	4.5	5	5.5	8	9
	50Pa	W	High	28	42	50	60	77	87	103
			Medium	22.5	33	45	52.5	60.5	73	85.5
			Low	12.5	17	23.5	27	29	36	42
			Super Low	4	4.5	4.5	5	5.5	8	9
Sound Pressure Level	12Pa	dBA	High	34	35	36.5	40.5	44.5	43	43.5
			Medium	28.5	31.5	33	36.5	39.5	38	38.5
			Low	25.5	27	28.5	30.5	33	32	33
			Super Low	18.5	19	19.5	19	19.5	19.5	20
	30Pa	dBA	High	38	39	41	43.5	46	43	46
			Medium	32.5	37	39	40.5	44	41.5	43.5
			Low	30.5	34.5	36	38.5	39.5	39	39.5
			Super Low	19	19	19	19.5	19	19	19.5
	50Pa	dBA	High	41	42.5	44.5	45.5	47	45	48.5
			Medium	35	39	40.5	43.5	43	43.5	46.5
			Low	33.5	37.5	39	41.5	41	41.5	44
			Super Low	18.5	18.5	18	19.5	19	19	19.5
Net Weight	Without Plenum		kg	11.5	14.5	16	17	20	26.9	28
	With Rear Plenum		kg	15	18	20	21	24.5	32.9	34
	With Bottom Plenum		kg	15	18.5	20.5	22	25	33.4	34.5
Fan	Type	Forward-Curve Multi-Blades Centrifugal Fan								
	Quantity	1	2	2	2	2	3	3		
Motor	Type	Brushless DC Motor								
	Protection Grade	IP42								
	Insulation Class	Class B								
	Quantity	1	1	1	1	1	2	2		
Coil	Type	Copper Tube / Hydrophilic Aluminum Fin								
	Working Pressure	1.8 MPa								
Connection	Water Inlet/Outlet	Rc 3/4" (Female)								
	Condensate Outlet	R 3/4" (Male)								
Options			Return Air Plenum, Filter, Valve, Thermostat, Various Drain Pans							

Notes: 1. Airflow, cooling and heating capacities, etc. are performance data of bare unit (i.e. without return air plenum).

2. Normal Application:

- Cooling: inlet air dry/wet bulb temperature: 27/19.5°C; chilled water inlet/outlet temperature: 7/12°C.
- Heating: inlet air dry bulb temperature: 21°C; hot water inlet temperature: 60°C; same water flow rate as cooling.

3. Sound pressure data are bare unit (i.e. without return air plenum) tested in semi-anechoic room according to China standard GB/T 19232.

Performance Data

4 Rows Unit (2-Pipe)

Unit Size			DCHC02	DCHC03	DCHC04	DCHC05	DCHC06	DCHC07	DCHC08	DCHC10	DCHC12	DCHC14	
Airflow	m ³ /h	High	340	510	680	850	1020	1190	1360	1700	2040	2380	
		Medium	280	410	550	690	830	970	1100	1360	1630	1900	
		Low	180	270	350	440	520	610	690	860	1020	1190	
Normal Application	Cooling Capacity	kW	High	2.54	3.66	4.73	5.55	7.01	7.90	9.21	11.16	13.07	14.93
	Heating Capacity	kW	High	4.00	5.69	7.20	8.82	10.73	12.10	14.17	17.61	20.16	23.43
	Water Flow Rate	l/s	High	0.12	0.18	0.23	0.27	0.33	0.38	0.44	0.53	0.62	0.71
	Water Pressure Drop	kPa	High	16	20	30	30	34	33	35	40	40	50
EarthWise Application	Cooling Capacity	kW	High	2.47	3.56	4.58	5.60	7.24	7.80	8.79	10.76	13.05	15.17
	Heating Capacity	kW	High	3.76	5.40	6.72	8.43	10.37	11.70	13.35	16.64	18.87	21.79
	Water Flow Rate	l/s	High	0.08	0.12	0.14	0.17	0.22	0.23	0.29	0.34	0.40	0.42
Water Pressure Drop	kPa	High	16	30	28	24	40	30	40	40	40	50	
Electric Heater Heating Capacity		kW	High	0.50	1.00	1.40	1.60	1.80	2.30	2.80	3.20	3.60	4.60
Power Input	12Pa	W	High	15	21	28	35	50	59	69	89	103	142
			Medium	11	16	20	28	37	42	48.5	66.5	87	127
			Low	6.5	8	9	12	14	20	22.5	26	32.5	45
			Super Low	4	4.5	4.5	5	5.5	8	9	9.5	10	10.5
	30Pa	W	High	20	30	37	47	63	67	84	106	122	167
			Medium	16.5	23.5	32	39.5	51	57	70.5	85.5	107.5	146.5
			Low	9	12.5	15.5	19	20	24	29.5	37	41.5	52
			Super Low	4	4.5	4.5	5	5.5	8	9	9.5	10	10.5
	50Pa	W	High	28	42	50	60	77	87	103	127	156	200
			Medium	22.5	33	45	52.5	60.5	73	85.5	113	130	172.5
			Low	12.5	17	23.5	27	29	36	42	56	59	70.5
			Super Low	4	4.5	4.5	5	5.5	8	9	9.5	10	10.5
Sound Pressure Level	12Pa	dBA	High	33	33.5	35	39	43	43	42	45	45.5	48.5
			Medium	27.5	30	31.5	35	38	38	37	41	42	45
			Low	24.5	25.5	27	29	31.5	32	31.5	34	35	37.5
			Super Low	17.5	17.5	18	17.5	18	19.5	18.5	19.5	19.5	19.5
	30Pa	dBA	High	37	37.5	39.5	42	44.5	43	44.5	47.5	48.5	50
			Medium	31.5	35.5	37.5	39	42.5	41.5	42	44.5	45.5	47.5
			Low	29.5	33	34.5	37	38	39	38	42	43	45
			Super Low	18	17.5	17.5	18	17.5	19	18	19.5	20	20
	50Pa	dBA	High	40	41	43	44	45.5	45	47	49.5	50	52
			Medium	34	37.5	39	42	41.5	43.5	45	47	47	49.5
			Low	32.5	36	37.5	40	39.5	41.5	42.5	45	44.5	46.5
			Super Low	17.5	17	16.5	18	17.5	19	18	19	19	19.5
Net Weight	Without Plenum	kg	12.5	15.5	17	18.5	21.5	27.5	29.5	33.5	36.5	39	
	With Rear Plenum	kg	15.5	19	21	22.5	26	33.5	35.5	40	44.5	47.5	
	With Bottom Plenum	kg	16	19.5	21.5	23	26.5	34	36	40.5	45	48	
Fan	Type	Forward-Curve Multi-Blades Centrifugal Fan											
	Quantity	1	2	2	2	2	3	3	4	4	4		
Motor	Type	Brushless DC Motor											
	Protection Grade	IP42											
	Insulation Class	Class B											
	Quantity	1	1	1	1	1	2	2	2	2	2		
Coil	Type	Copper Tube / Hydrophilic Aluminum Fin											
	Working Pressure	1.8 MPa											
Connection	Water Inlet/Outlet	Rc 3/4" (Female)											
	Condensate Outlet	R 3/4" (Male)											
Options		Return Air Plenum, Filter, Valve, Thermostat, Various Drain Pans											

Notes: 1. Airflow, cooling and heating capacities, etc. are performance data of bare unit (i.e. without return air plenum).

2. Normal Application:

- Cooling: inlet air dry/wet bulb temperature: 27/19.5°C; chilled water inlet/outlet temperature: 7/12°C.
- Heating: inlet air dry bulb temperature: 21°C; hot water inlet temperature: 60°C; same water flow rate as cooling.

3. EarthWise Application:

- Cooling: inlet air dry/wet bulb temperature: 27/19.5°C; chilled water inlet/outlet temperature: 5/13°C.
- Heating: inlet air dry bulb temperature: 21°C; hot water inlet temperature: 60°C; same water flow rate as cooling.

4. Sound pressure data are bare unit (i.e. without return air plenum) tested in semi-anechoic room according to China standard GB/T 19232.

2+1 Rows Unit (4-Pipe)

Unit Size			DCHC02	DCHC03	DCHC04	DCHC05	DCHC06	DCHC08	
Airflow	m ³ /h	High	340	510	680	850	1020	1360	
		Medium	280	410	550	690	830	1100	
		Low	180	270	350	440	520	690	
Normal Application	Cooling Capacity	kW	High 1.93	2.86	3.81	4.50	5.74	7.22	
	Water Flow Rate	l/s	High 0.10	0.14	0.19	0.22	0.28	0.35	
	Water Pressure Drop	kPa	High 8	16	26	21	25	28	
Heating Capacity		kW	High 1.67	2.21	2.50	2.92	3.45	4.11	
Water Flow Rate		l/s	High 0.07	0.06	0.06	0.06	0.06	0.05	
Water Pressure Drop		kPa	High 30	30	30	30	40	40	
Power Input	12Pa	W	High	15	21	28	35	50	69
			Medium	11	16	20	28	37	48.5
			Low	6.5	8	9	12	14	22.5
			Super Low	4	4.5	4.5	5	5.5	9
	30Pa	W	High	20	30	37	47	63	84
			Medium	16.5	23.5	32	39.5	51	70.5
			Low	9	12.5	15.5	19	20	29.5
			Super Low	4	4.5	4.5	5	5.5	9
	50Pa	W	High	28	42	50	60	77	103
			Medium	22.5	33	45	52.5	60.5	85.5
			Low	12.5	17	23.5	27	29	42
			Super Low	4	4.5	4.5	5	5.5	9
Sound Pressure Level	12Pa	dBA	High	34	34.5	36	40	44	43
			Medium	28.5	31	32.5	36	39	38
			Low	25.5	26.5	28	30	32.5	32.5
			Super Low	18.5	18.5	19	18.5	19	19.5
	30Pa	dBA	High	38	38.5	40.5	43	45.5	45.5
			Medium	32.5	36.5	38.5	40	43.5	43
			Low	30.5	34	35.5	38	39	39
			Super Low	19	18.5	18.5	19	18.5	19
	50Pa	dBA	High	41	42	44	45	46.5	48
			Medium	35	38.5	40	43	42.5	46
			Low	33.5	37	38.5	41	40.5	43.5
			Super Low	18.5	18	17.5	19	18.5	19
Net Weight	Without Plenum		kg	12.5	15.0	16.5	18.0	21.0	29.0
	With Rear Plenum		kg	16.0	18.5	20.5	22.0	25.5	35.0
	With Bottom Plenum		kg	16.0	19.0	21.0	23.0	26.0	35.5
Fan	Type	Forward-Curve Multi-Blades Centrifugal Fan							
	Quantity	1	2	2	2	2	3		
Motor	Type	Brushless DC Motor							
	Protection Grade	IP42							
	Insulation Class	Class B							
	Quantity	1	1	1	1	1	2		
Coil	Type	Copper Tube / Hydrophilic Aluminum Fin							
	Working Pressure	1.8 MPa							
Connection	Water Inlet/Outlet	2-Row: Rc 3/4" (Female), 1-Row: Rc 1/2" (Female)							
	Condensate Outlet	R 3/4"(Male)							
Options			Return Air Plenum, Filter, Valve, Thermostat, Various Drain Pans						

Notes: 1. Airflow, cooling and heating capacities, etc. are performance data of bare unit (i.e. without return air plenum).

2. Normal Application:

- Cooling: inlet air dry/wet bulb temperature: 27/19.5°C; chilled water inlet/outlet temperature: 7/12°C.
- Heating: inlet air dry bulb temperature: 21°C; hot water inlet temperature: 60°C; water flow rate according to catalog data.

3. Sound pressure data are bare unit (i.e. without return air plenum) tested in semi-anechoic room according to China standard GB/T 19232.

Performance Data

3+1 Rows Unit (4-Pipe)

Unit Size			DCHC02	DCHC03	DCHC04	DCHC05	DCHC06	DCHC07	DCHC08	DCHC10	DCHC12	DCHC14	
Airflow	m ³ /h	High	340	510	680	850	1020	1190	1360	1700	2040	2380	
		Medium	280	410	550	690	830	970	1100	1360	1630	1900	
		Low	180	270	350	440	520	610	690	860	1020	1190	
Normal Application	Cooling Capacity	kW	High	2.17	3.10	4.04	4.96	5.98	6.80	7.62	9.02	10.80	12.74
	Water Flow Rate	l/s	High	0.11	0.15	0.20	0.24	0.30	0.32	0.37	0.44	0.52	0.62
	Water Pressure Drop	kPa	High	25	24	23	30	38	30	32	33	38	50
EarthWise Application	Cooling Capacity	kW	High	2.17	2.95	3.97	4.69	5.86	6.80	7.61	9.32	10.80	13.02
	Water Flow Rate	l/s	High	0.07	0.10	0.12	0.15	0.18	0.20	0.23	0.28	0.32	0.39
	Water Pressure Drop	kPa	High	26	18	30	22	38	30	26	28	29	48
Heating Capacity		kW	High	2.06	2.85	3.68	4.37	4.68	5.50	6.18	7.29	8.76	10.12
Water Flow Rate		l/s	High	0.05	0.07	0.09	0.10	0.12	0.13	0.15	0.18	0.22	0.25
Water Pressure Drop		kPa	High	4	9	17	27	6	8	11	16	27	33
Power Input	12Pa	W	High	15	21	28	35	50	59	69	89	103	142
			Medium	11	16	20	28	37	42	48.5	66.5	87	127
			Low	6.5	8	9	12	14	20	22.5	26	32.5	45
			Super Low	4	4.5	4.5	5	5.5	8	9	9.5	10	10.5
	30Pa	W	High	20	30	37	47	63	67	84	106	122	167
			Medium	16.5	23.5	32	39.5	51	57	70.5	85.5	107.5	146.5
			Low	9	12.5	15.5	19	20	24	29.5	37	41.5	52
			Super Low	4	4.5	4.5	5	5.5	8	9	9.5	10	10.5
	50Pa	W	High	28	42	50	60	77	87	103	127	156	200
			Medium	22.5	33	45	52.5	60.5	73	85.5	113	130	172.5
			Low	12.5	17	23.5	27	29	36	42	56	59	70.5
			Super Low	4	4.5	4.5	5	5.5	8	9	9.5	10	10.5
Sound Pressure Level	12Pa	dBA	High	33	33.5	35	39	43	43	42	45	45.5	48.5
			Medium	27.5	30	31.5	35	38	38	37	41	42	45
			Low	24.5	25.5	27	29	31.5	32	31.5	34	35	37.5
			Super Low	17.5	17.5	18	17.5	18	19.5	18.5	19.5	19.5	19.5
	30Pa	dBA	High	37	37.5	39.5	42	44.5	43	44.5	47.5	48.5	50
			Medium	31.5	35.5	37.5	39	42.5	41.5	42	44.5	45.5	47.5
			Low	29.5	33	34.5	37	38	39	38	42	43	45
			Super Low	18	17.5	17.5	18	17.5	19	18	19.5	20	20
	50Pa	dBA	High	40	41	43	44	45.5	45	47	49.5	50	52
			Medium	34	37.5	39	42	41.5	43.5	45	47	47	49.5
			Low	32.5	36	37.5	40	39.5	41.5	42.5	45	44.5	46.5
			Super Low	17.5	17	16.5	18	17.5	19	18	19	19	19.5
Net Weight	Without Plenum		kg	13.0	15.5	17.0	18.5	21.5	27.5	30.0	33.5	37.0	39.5
	With Rear Plenum		kg	16.5	19.0	21.0	23.0	26.5	33.5	36.0	40.5	44.5	47.5
	With Bottom Plenum		kg	16.5	19.5	21.5	23.5	27.0	34.0	36.5	41.0	45.0	48.5
Fan	Type	Forward-Curve Multi-Blades Centrifugal Fan											
	Quantity	1	2	2	2	2	3	3	4	4	4	4	
Motor	Type	Brushless DC Motor											
	Protection Grade	IP42											
	Insulation Class	Class B											
Coil	Quantity	1	1	1	1	1	2	2	2	2	2	2	
	Type	Copper Tube / Hydrophilic Aluminum Fin											
Connection	Working Pressure	1.8 MPa											
	Water Inlet/Outlet	3-Row: Rc 3/4" (Female), 1-Row: Rc 1/2" (Female)											
	Condensate Outlet	R 3/4"(Male)											
Options		Return Air Plenum, Filter, Valve, Thermostat, Various Drain Pans											

Notes:1. Airflow, cooling and heating capacities, etc. are performance data of bare unit (i.e. without return air plenum).

2. Normal Application:

- Cooling: inlet air dry/wet bulb temperature: 27/19.5°C; chilled water inlet/outlet temperature: 7/12°C.
- Heating: inlet air dry bulb temperature: 21°C; hot water inlet temperature: 60°C; water flow rate according to catalog data.

3. EarthWise Application:

- Cooling: inlet air dry/wet bulb temperature: 27/19.5°C; chilled water inlet/outlet temperature: 5/13°C.
- Heating: inlet air dry bulb temperature: 21°C; hot water inlet temperature: 60°C; water flow rate according to catalog data.

4. Sound pressure data are bare unit (i.e. without return air plenum) tested in semi-anechoic room according to China standard GB/T 19232.

HESP 3 Rows Unit (2-Pipe)

Unit Size				DCHC02	DCHC03	DCHC04	DCHC05	DCHC06	DCHC07	DCHC08	DCHC10	DCHC12	DCHC14
Normal Application	Airflow	m ³ /h	High	340	510	680	850	1020	1190	1360	1700	2040	2380
	Cooling Capacity	kW	High	2.21	3.16	4.17	5.06	6.10	7.00	8.00	9.30	11.10	13.00
	Heating Capacity	kW	High	3.50	5.20	6.70	8.12	9.70	11.35	13.00	15.50	18.00	20.80
	Water Flow Rate	l/s	High	0.11	0.15	0.20	0.25	0.30	0.34	0.39	0.45	0.53	0.63
EarthWise Application	Water Pressure Drop	kPa	High	25	24	25	30	40	33	35	35	40	50
	Cooling Capacity	kW	High	2.21	3.14	3.99	5.02	6.10	7.20	7.98	9.85	11.31	13.29
	Heating Capacity	kW	High	3.37	4.84	6.32	7.56	9.16	11.00	12.27	14.92	17.15	19.95
	Water Flow Rate	l/s	High	0.07	0.10	0.12	0.16	0.20	0.21	0.24	0.29	0.34	0.40
High Capacity EarthWise Application	Water Pressure Drop	kPa	High	29	22	17	29	40	34	33	36	35	50
	Cooling Capacity	kW	Medium	-	2.06	2.70	3.39	4.20	4.6	5.41	6.53	7.49	8.87
	Heating Capacity	kW	Medium	-	3.61	4.73	5.93	7.35	10.80	9.47	11.43	13.11	15.52
	Water Flow Rate	l/s	Medium	-	0.06	0.08	0.11	0.12	0.13	0.16	0.19	0.22	0.27
Power Input	Water Pressure Drop	kPa	Medium	-	28	20	30	22	30	40	35	35	48
	112Pa	W		49	77	88	110	137	155	187	231	280	344
	100Pa		45	70	80	100	125	145	170	210	255	315	
	88Pa		41	63	73	90	113	134	153	189	230	286	
	75Pa		37	56	65	80	101	119	137	169	206	258	
	62Pa		32	49	58	70	89	109	120	148	181	229	
Super Low	4.5		5	5	5.5	6	11	9.5	10	10	10.5		
Sound Pressure Level	112Pa	dBA		45.0	49.0	49.0	51.5	51.0	49.0	52.5	53.5	53.0	54.0
	100Pa		43.5	48.0	47.5	50.0	50.0	48.0	51.0	52.5	52.0	53.0	
	88Pa		42.0	46.5	46.5	49.0	49.0	47.0	50.0	51.5	51.5	52.5	
	75Pa		40.5	45.0	45.0	47.5	48.0	46.0	49.0	50.5	50.5	51.5	
	62Pa		38.5	43.0	44.0	46.0	47.0	45.0	47.5	49.5	48.5	50.5	
	Super Low		19.0	19.0	19.0	19.0	19.0	19.0	19.0	19.0	19.0	19.0	
Net Weight	Without Plenum	kg		12.4	15.3	16.9	18.1	21.1	28	29.9	32.8	36.5	38.9
	With Rear Plenum	kg		15.4	18.8	20.9	22.6	26.1	34	35.9	39.8	44	46.9
	With Bottom Plenum	kg		15.9	19.3	21.4	23.1	26.6	34.5	36.4	40.3	44.5	47.9
Fan	Type	Forward-Curve Multi-Blades Centrifugal Fan											
	Quantity	1	2	2	2	2	3	3	4	4	4		
Motor	Type	Brushless DC Motor											
	Protection Grade	IP42											
	Insulation Class	Class B											
	Quantity	1	1	1	1	1	2	2	2	2	2		
Coil	Type	Copper Tube / Hydrophilic Aluminum Fin											
	Working Pressure	1.8 MPa											
Connection	Water Inlet/Outlet	Rc 3/4" (Female)											
	Condensate Outlet	R 3/4" (Male)											
Options			Return Air Plenum, Filter, Valve, Thermostat, Various Drain Pans										

Notes: 1. Airflow, cooling and heating capacities, etc. are performance data of bare unit (i.e. without return air plenum).

2. Normal Application:

- Cooling: inlet air dry/wet bulb temperature: 27/19.5°C; chilled water inlet/outlet temperature: 7/12°C.
- Heating: inlet air dry bulb temperature: 21°C; hot water inlet temperature: 60°C; same water flow rate as cooling.

3. EarthWise Application:

- Cooling: inlet air dry/wet bulb temperature: 27/19.5°C; chilled water inlet/outlet temperature: 5/13°C.
- Heating: inlet air dry bulb temperature: 21°C; hot water inlet temperature: 60°C; same water flow rate as cooling.

4. High Capacity EarthWise Application:

- Cooling: inlet air dry/wet bulb temperature: 26.7/19.4°C; chilled water inlet/outlet temperature: 7.2/15.6°C.
- Heating: inlet air dry bulb temperature: 21°C; hot water inlet temperature: 60°C; same water flow rate as cooling.

5. Sound pressure data are bare unit (i.e. without return air plenum) tested in semi-anechoic room according to China standard GB/T 19232.

Performance Data

HESP 2 Rows Unit (2-Pipe)

Unit Size				DCHC02	DCHC03	DCHC04	DCHC05	DCHC06	DCHC07	DCHC08
Normal Application	Airflow	m ³ /h	High	350	520	690	870	1040	1210	1380
	Cooling Capacity	kW	High	1.90	2.80	3.60	4.50	5.40	6.30	7.20
	Heating Capacity	kW	High	3.15	4.93	6.10	7.41	8.90	11.0	12.00
	Water Flow Rate	l/s	High	0.10	0.14	0.17	0.21	0.26	0.31	0.34
Power Input	Water Pressure Drop	kPa	High	15	30	25	30	34	40	36
	112Pa	W		49	77	88	110	137	155	187
	100Pa			45	70	80	100	125	145	170
	88Pa			41	63	73	90	113	134	153
	75Pa			37	56	65	80	101	119	137
	62Pa			32	49	58	70	89	109	120
	Super Low			4.5	5	5	5.5	6	11	9.5
Sound Pressure Level	112Pa		dBA		45.5	49.5	49.5	52.0	51.5	49.0
	100Pa			44.0	48.5	48.0	50.5	50.5	48.0	51.5
	88Pa			42.5	47.0	47.0	49.5	49.5	47.0	50.5
	75Pa			41.0	45.5	45.5	48.0	48.5	46.0	49.5
	62Pa			39.0	43.5	44.5	46.5	47.5	45.0	48.0
	Super Low			19.0	19.0	19.0	19.0	19.0	19.0	19.0
Net Weight	Without Plenum	kg		11.9	14.8	16.4	17.6	20.6	27.9	28.9
	With Rear Plenum	kg		15.4	18.3	20.4	21.6	25.1	33.9	34.9
	With Bottom Plenum	kg		15.4	18.8	20.9	22.6	25.6	34.4	35.4
Fan	Type	Forward-Curve Multi-Blades Centrifugal Fan								
	Quantity	1	2	2	2	2	3	3		
Motor	Type	Brushless DC Motor								
	Protection Grade	IP42								
	Insulation Class	Class B								
Coil	Quantity	1	1	1	1	1	2	2		
	Type	Copper Tube / Hydrophilic Aluminum Fin								
Connection	Working Pressure	1.8 MPa								
	Water Inlet/Outlet	Rc 3/4" (Female)								
	Condensate Outlet	R 3/4" (Male)								
Options			Return Air Plenum, Filter, Valve, Thermostat, Various Drain Pans							

Notes: 1. Airflow, cooling and heating capacities, etc. are performance data of bare unit (i.e. without return air plenum).

2. Normal Application:

- Cooling: inlet air dry/wet bulb temperature: 27/19.5°C; chilled water inlet/outlet temperature: 7/12°C.
- Heating: inlet air dry bulb temperature: 21°C; hot water inlet temperature: 60°C; same water flow rate as cooling.

3. Sound pressure data are bare unit (i.e. without return air plenum) tested in semi-anechoic room according to China standard GB/T 19232.

HESP 4 Rows Unit (2-Pipe)

Unit Size				DCHC02	DCHC03	DCHC04	DCHC05	DCHC06	DCHC07	DCHC08	DCHC10	DCHC12	DCHC14
Normal Application	Airflow	m ³ /h	High	340	510	680	850	1020	1190	1360	1700	2040	2380
	Cooling Capacity	kW	High	2.54	3.66	4.73	5.55	7.01	7.90	9.21	11.16	13.07	14.93
	Heating Capacity	kW	High	4.00	5.69	7.20	8.82	10.73	12.10	14.17	17.61	20.16	23.43
	Water Flow Rate	l/s	High	0.12	0.18	0.23	0.27	0.33	0.38	0.44	0.53	0.62	0.71
EarthWise Application	Water Pressure Drop	kPa	High	16	20	30	30	34	33	35	40	40	50
	Cooling Capacity	kW	High	2.47	3.56	4.58	5.60	7.24	7.80	8.79	10.76	13.05	15.17
	Heating Capacity	kW	High	3.76	5.40	6.72	8.43	10.37	11.70	13.35	16.64	18.87	21.79
	Water Flow Rate	l/s	High	0.08	0.12	0.14	0.17	0.22	0.23	0.29	0.34	0.40	0.42
Power Input	112Pa	W		49	77	88	110	137	155	187	231	280	344
	100Pa		45	70	80	100	125	145	170	210	255	315	
	88Pa		41	63	73	90	113	134	153	189	230	286	
	75Pa		37	56	65	80	101	119	137	169	206	258	
	62Pa		32	49	58	70	89	109	120	148	181	229	
	Super Low		4.5	5	5	5.5	6	11	9.5	10	10	10.5	
Sound Pressure Level	112Pa	dBA		44.5	48.5	48.5	51.5	51.0	49.0	53.0	53.5	53.5	54.0
	100Pa		43.0	47.5	47.5	50.0	50.0	48.0	51.5	52.5	52.5	53.0	
	88Pa		41.5	46.5	46.0	49.0	49.0	47.0	50.5	51.5	52.0	53.0	
	75Pa		39.5	44.5	44.5	47.5	47.5	46.0	49.5	50.5	50.5	52.0	
	62Pa		37.5	42.5	43.5	45.5	47.0	45.0	48.0	49.0	49.0	51.0	
	Super Low		19.0	19.0	19.0	19.0	19.0	19.0	19.0	19.0	19.0	19.0	19.0
Net Weight	Without Plenum	kg		12.9	15.8	17.4	19.1	22.1	28.5	30.4	34.3	37.5	39.9
	With Rear Plenum	kg		15.9	19.3	21.4	23.1	26.6	34.5	36.4	40.8	45.5	48.4
	With Bottom Plenum	kg		16.4	19.8	21.9	23.6	27.1	35	36.9	41.3	46	48.9
Fan	Type	Forward-Curve Multi-Blades Centrifugal Fan											
	Quantity	1	2	2	2	2	3	3	4	4	4		
Motor	Type	Brushless DC Motor											
	Protection Grade	IP42											
	Insulation Class	Class B											
	Quantity	1	1	1	1	1	2	2	2	2	2		
Coil	Type	Copper Tube / Hydrophilic Aluminum Fin											
	Working Pressure	1.8 MPa											
Connection	Water Inlet/Outlet	Rc 3/4" (Female)											
	Condensate Outlet	R 3/4"(Male)											
Options			Return Air Plenum, Filter, Valve, Thermostat, Various Drain Pans										

Notes:1. Airflow, cooling and heating capacities, etc. are performance data of bare unit (i.e. without return air plenum).

2. Normal Application:

- Cooling: inlet air dry/wet bulb temperature: 27/19.5°C; chilled water inlet/outlet temperature: 7/12°C.
- Heating: inlet air dry bulb temperature: 21°C; hot water inlet temperature: 60°C; same water flow rate as cooling.

3. EarthWise Application:

- Cooling: inlet air dry/wet bulb temperature: 27/19.5°C; chilled water inlet/outlet temperature: 5/13°C.
- Heating: inlet air dry bulb temperature: 21°C; hot water inlet temperature: 60°C; same water flow rate as cooling.

4. Sound pressure data are bare unit (i.e. without return air plenum) tested in semi-anechoic room according to China standard GB/T 19232.

Performance Data

HESP 2+1 Rows Unit (4-Pipe)

Unit Size				DCHC02	DCHC03	DCHC04	DCHC05	DCHC06	DCHC08
Normal Application	Airflow	m ³ /h	High	340	510	680	850	1020	1360
	Cooling Capacity	kW	High	1.93	2.86	3.81	4.50	5.74	7.22
	Water Flow Rate	l/s	High	0.10	0.14	0.19	0.22	0.28	0.35
	Water Pressure Drop	kPa	High	8	16	26	21	25	28
	Heating Capacity	kW	High	1.67	2.21	2.50	2.92	3.45	4.11
	Water Flow Rate	l/s	High	0.07	0.06	0.06	0.06	0.06	0.05
	Water Pressure Drop	kPa	High	30	30	30	30	40	40
Power Input	112Pa	W		49	77	88	110	137	187
	100Pa		45	70	80	100	125	170	
	88Pa		41	63	73	90	113	153	
	75Pa		37	56	65	80	101	137	
	62Pa		32	49	58	70	89	120	
	Super Low		4.5	5	5	5.5	6	9.5	
Sound Pressure Level	112Pa	dBA		45.0	49.0	49.0	51.5	51.0	52.5
	100Pa		43.5	48.0	47.5	50.0	50.0	51.0	
	88Pa		42.0	46.5	46.5	49.0	49.0	50.0	
	75Pa		40.5	45.0	45.0	47.5	48.0	49.0	
	62Pa		38.5	43.0	44.0	46.0	47.0	47.5	
	Super Low		19.0	19.0	19.0	19.0	19.0	19.0	
Net Weight	Without Plenum	kg		12.9	15.3	16.9	18.6	21.6	29.9
	With Rear Plenum	kg		16.4	18.8	20.9	22.6	26.1	35.9
	With Bottom Plenum	kg		16.4	19.3	21.4	23.6	26.6	36.4
Fan	Type	Forward-Curve Multi-Blades Centrifugal Fan							
	Quantity		1	2	2	2	2	3	
Motor	Type	Brushless DC Motor							
	Protection Grade	IP42							
	Insulation Class	Class B							
	Quantity		1	1	1	1	1	2	
Coil	Type	Copper Tube / Hydrophilic Aluminum Fin							
	Working Pressure	1.8 MPa							
Connection	Water Inlet/Outlet	Rc 3/4" (Female)							
	Condensate Outlet	R 3/4" (Male)							
Options			Return Air Plenum, Filter, Valve, Thermostat, Various Drain Pans						

Notes: 1. Airflow, cooling and heating capacities, etc. are performance data of bare unit (i.e. without return air plenum).

2. Normal Application:

- Cooling: inlet air dry/wet bulb temperature: 27/19.5°C; chilled water inlet/outlet temperature: 7/12°C.
- Heating: inlet air dry bulb temperature: 21°C; hot water inlet temperature: 60°C; water flow rate according to catalog data.

3. Sound pressure data are bare unit (i.e. without return air plenum) tested in semi-anechoic room according to China standard GB/T 19232.

HESP 3+1 Rows Unit (4-Pipe)

Unit Size				DCHC02	DCHC03	DCHC04	DCHC05	DCHC06	DCHC07	DCHC08	DCHC10	DCHC12	DCHC14
Airflow		m ³ /h	High	340	510	680	850	1020	1190	1360	1700	2040	2380
Normal Application	Cooling Capacity	kW	High	2.17	3.10	4.04	4.96	5.98	6.80	7.62	9.02	10.80	12.74
	Water Flow Rate	l/s	High	0.11	0.15	0.20	0.24	0.30	0.32	0.37	0.44	0.52	0.62
	Water Pressure Drop	kPa	High	25	24	23	30	38	30	32	33	38	50
EarthWise Application	Cooling Capacity	kW	High	2.17	2.95	3.97	4.69	5.86	6.80	7.61	9.32	10.80	13.02
	Water Flow Rate	l/s	High	0.07	0.10	0.12	0.15	0.18	0.20	0.23	0.28	0.32	0.39
	Water Pressure Drop	kPa	High	26	18	30	22	38	30	26	28	29	48
Heating Capacity		kW	High	2.06	2.85	3.68	4.37	4.68	5.50	6.18	7.29	8.76	10.12
Water Flow Rate		l/s	High	0.05	0.07	0.09	0.10	0.12	0.13	0.15	0.18	0.22	0.25
Water Pressure Drop		kPa	High	4	9	17	27	6	8	11	16	27	33
Power Input	112Pa	W		49	77	88	110	137	155	187	231	280	344
	100Pa			45	70	80	100	125	145	170	210	255	315
	88Pa			41	63	73	90	113	134	153	189	230	286
	75Pa			37	56	65	80	101	119	137	169	206	258
	62Pa			32	49	58	70	89	109	120	148	181	229
	Super Low			4.5	5	5	5.5	6	11	9.5	10	10	10.5
Sound Pressure Level	112Pa	dBA		44.5	48.5	48.5	51.5	51.0	49.0	53.0	53.5	53.5	54.0
	100Pa			43.0	47.5	47.5	50.0	50.0	48.0	51.5	52.5	52.5	53.0
	88Pa			41.5	46.5	46.0	49.0	49.0	47.0	50.5	51.5	52.0	53.0
	75Pa			39.5	44.5	44.5	47.5	47.5	46.0	49.5	50.5	50.5	52.0
	62Pa			37.5	42.5	43.5	45.5	47.0	45.0	48.0	49.0	49.0	51.0
	Super Low			19.0	19.0	19.0	19.0	19.0	19.0	19.0	19.0	19.0	19.0
Net Weight	Without Plenum	kg		13.4	15.8	17.4	19.1	22.1	28.5	30.9	34.3	38.0	40.4
	With Rear Plenum	kg		16.9	19.3	21.4	23.6	27.1	34.5	36.9	41.3	45.5	48.4
	With Bottom Plenum	kg		16.9	19.8	21.9	24.1	27.6	35.0	37.4	41.8	46.0	49.4
Fan	Type	Forward-Curve Multi-Blades Centrifugal Fan											
	Quantity	1	2	2	2	2	3	3	4	4	4		
Motor	Type	Brushless DC Motor											
	Protection Grade	IP42											
	Insulation Class	Class B											
	Quantity	1	1	1	1	1	2	2	2	2	2		
Coil	Type	Copper Tube / Hydrophilic Aluminum Fin											
	Working Pressure	1.8 MPa											
Connection	Water Inlet/Outlet	Rc 3/4" (Female)											
	Condensate Outlet	R 3/4"(Male)											
Options		Return Air Plenum, Filter, Valve, Thermostat, Various Drain Pans											

Notes:1. Airflow, cooling and heating capacities, etc. are performance data of bare unit (i.e. without return air plenum).

2. Normal Application:

- Cooling: inlet air dry/wet bulb temperature: 27/19.5°C; chilled water inlet/outlet temperature: 7/12°C.
- Heating: inlet air dry bulb temperature: 21°C; hot water inlet temperature: 60°C; water flow rate according to catalog data.

3. EarthWise Application:

- Cooling: inlet air dry/wet bulb temperature: 27/19.5°C; chilled water inlet/outlet temperature: 5/13°C.
- Heating: inlet air dry bulb temperature: 21°C; hot water inlet temperature: 60°C; water flow rate according to catalog data.

4. Sound pressure data are bare unit (i.e. without return air plenum) tested in semi-anechoic room according to China standard GB/T 19232.



Performance Data

DCHX 3 Rows Unit (2-Pipe)

Unit Size			DCHX02	DCHX03	DCHX04	DCHX05	DCHX06	DCHX07	DCHX08	DCHX10	DCHX12	DCHX14	
Airflow	m ³ /h	High	340	510	680	850	1020	1190	1360	1700	2040	2380	
		Medium	280	410	550	690	830	970	1100	1360	1630	1900	
		Low	180	270	350	440	520	610	690	860	1020	1190	
Normal Application	Cooling Capacity	kW	High	2.21	3.16	4.17	5.06	6.10	7.00	8.00	9.30	11.10	13.00
	Heating Capacity	kW	High	3.50	5.20	6.70	8.12	9.70	11.35	13.00	15.50	18.00	20.80
	Water Flow Rate	l/s	High	0.11	0.15	0.20	0.25	0.30	0.34	0.39	0.45	0.53	0.63
	Water Pressure Drop	kPa	High	25	24	25	30	40	33	35	35	40	50
EarthWise Application	Cooling Capacity	kW	High	2.21	3.14	3.99	5.02	6.10	7.20	7.98	9.85	11.31	13.29
	Heating Capacity	kW	High	3.37	4.84	6.32	7.56	9.16	11.00	12.27	14.92	17.15	19.95
	Water Flow Rate	l/s	High	0.07	0.10	0.12	0.16	0.20	0.21	0.24	0.29	0.34	0.40
	Water Pressure Drop	kPa	High	29	22	17	29	40	34	33	36	35	50
High Capacity EarthWise Application	Cooling Capacity	kW	Medium	-	2.06	2.70	3.39	4.20	4.60	5.41	6.53	7.49	8.87
	Heating Capacity	kW	Medium	-	3.61	4.73	5.93	7.35	10.80	9.47	11.43	13.11	15.52
	Water Flow Rate	l/s	Medium	-	0.06	0.08	0.11	0.12	0.13	0.16	0.19	0.22	0.27
	Water Pressure Drop	kPa	Medium	-	28	20	30	22	30	40	35	35	48
Power Input	0Pa	W	High	15	21	28	35	50	59	69	89	103	142
			Medium	11	16	20	28	37	42	48.5	66.5	87	127
			Low	6.5	8	9	12	14	20	22.5	26	32.5	45
			Super Low	4	4.5	4.5	5	5.5	8	9	9.5	10	10.5
Sound Pressure Level	0Pa	dBA	High	34	34.5	36	40	44	43	43	46	46.5	49.5
			Medium	28.5	31	32.5	36	39	38	38	42	43	46
			Low	25.5	26.5	28	30	32.5	32	32.5	35	36	38.5
			Super Low	18.5	18.5	19	18.5	19	19.5	19.5	20.5	20.5	20.5
Net Weight	With Rear Plenum	kg	25.1	29.7	32.6	34	39.5	47.6	50.7	56	62.1	66.3	
Fan	Type	Forward-Curve Multi-Blades Centrifugal Fan											
	Quantity	1	2	2	2	2	3	3	4	4	4		
Motor	Type	Brushless DC Motor											
	Protection Grade	IP42											
	Insulation Class	Class B											
	Quantity	1	1	1	1	1	2	2	2	2	2		
Coil	Type	Copper Tube / Hydrophilic Aluminum Fin											
	Working Pressure	1.8 MPa											
Connection	Water Inlet/Outlet	Rc 3/4" (Female)											
	Condensate Outlet	R 3/4" (Male)											
	Options	Filter, Valve, Thermostat											

Notes:1. Airflow, cooling and heating capacities, etc. are performance data of bare unit (i.e. without return air plenum).

2. Normal Application:

- Cooling: inlet air dry/wet bulb temperature: 27/19.5°C; chilled water inlet/outlet temperature: 7/12°C.
- Heating: inlet air dry bulb temperature: 21°C; hot water inlet temperature: 60°C; same water flow rate as cooling.

3. EarthWise Application:

- Cooling: inlet air dry/wet bulb temperature: 27/19.5°C; chilled water inlet/outlet temperature: 5/13°C.
- Heating: inlet air dry bulb temperature: 21°C; hot water inlet temperature: 60°C; same water flow rate as cooling.

4. High Capacity EarthWise Application:

- Cooling: inlet air dry/wet bulb temperature: 26.7/19.4°C; chilled water inlet/outlet temperature: 7.2/15.6°C.
- Heating: inlet air dry bulb temperature: 21°C; hot water inlet temperature: 60°C; same water flow rate as cooling.

5. Sound pressure data are bare unit (i.e. without return air plenum) tested in semi-anechoic room according to China standard GB/T 19232.

Airflow Curve

12Pa Motor

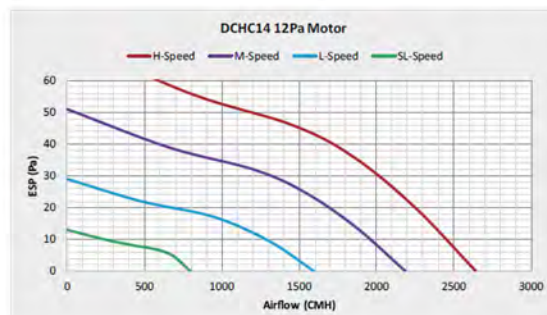
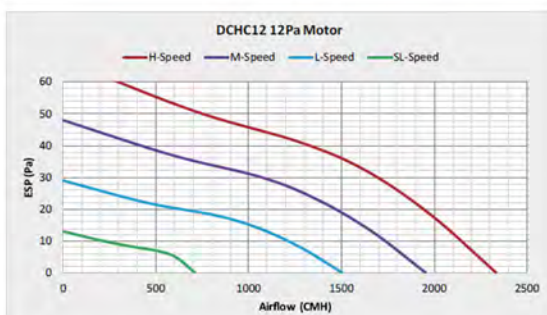
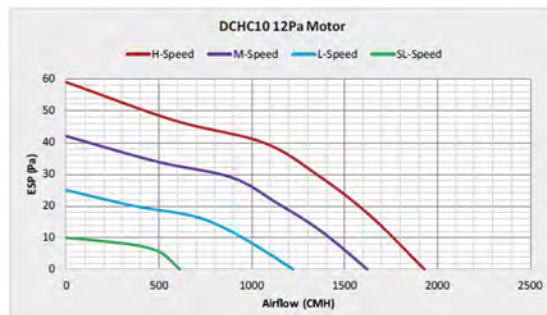
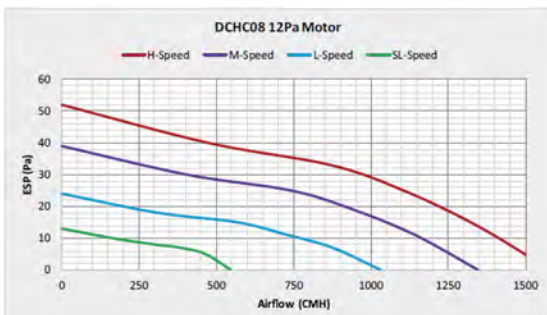
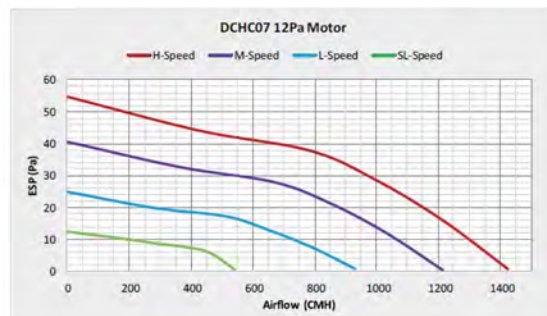
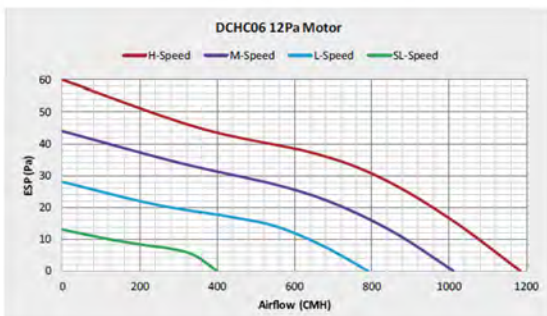
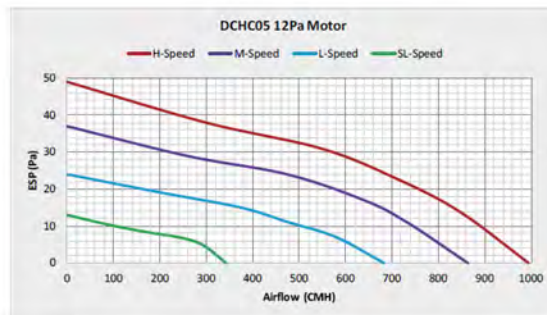
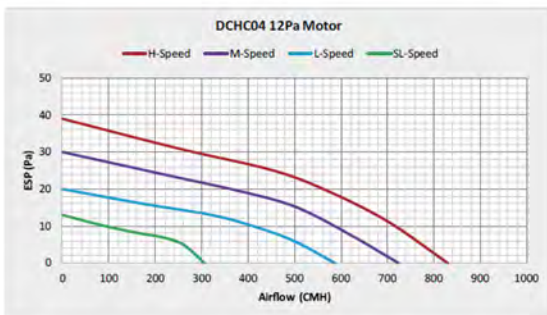
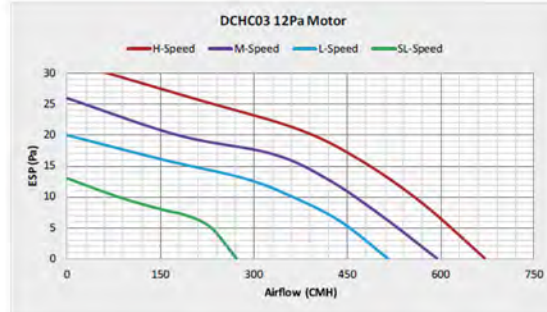
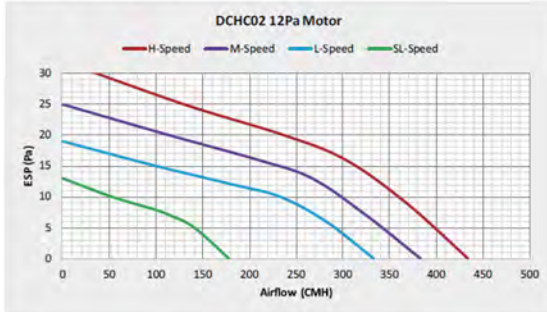

Notes:

1. The airflow curves are based on 3 row coil bare unit (i.e. without return air plenum).
2. Please use Trane TOPSS program or contact Trane sales to get selectable range for various configurations.

30Pa Motor

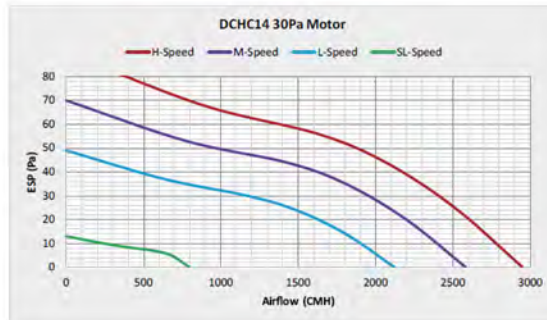
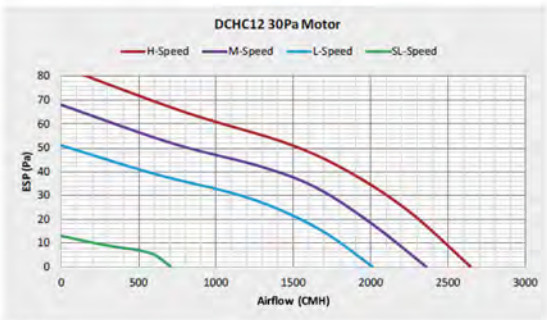
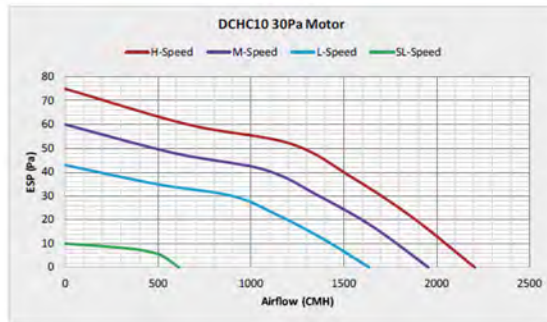
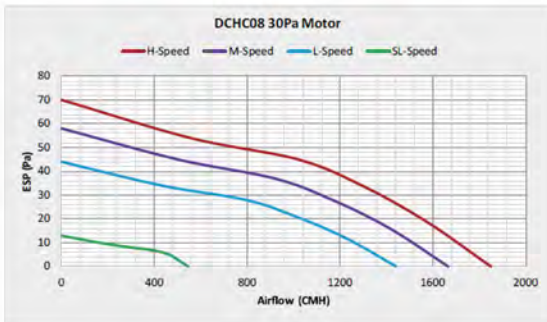
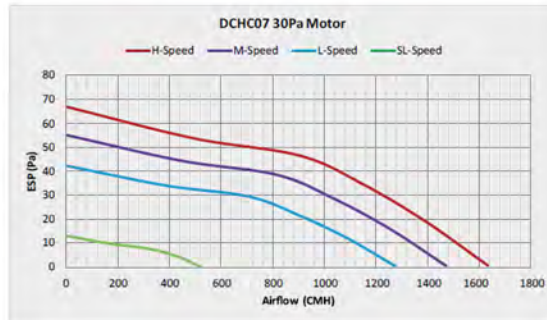
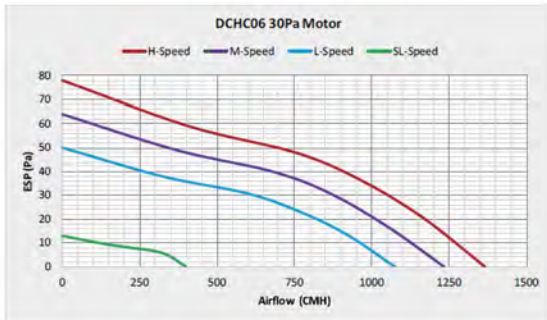
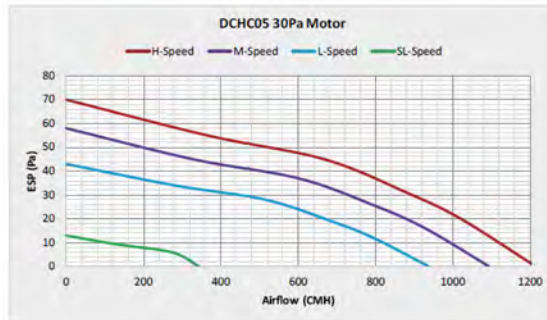
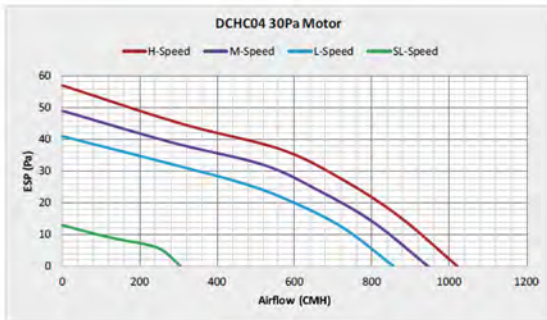
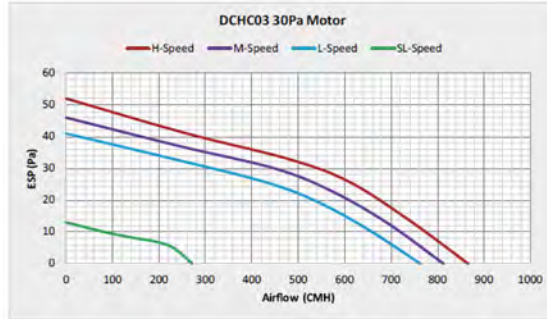
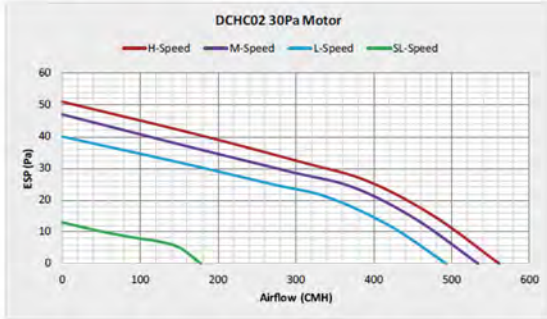

Notes:

1. The airflow curves are based on 3 row coil bare unit (i.e. without return air plenum).
2. Please use Trane TOPSS program or contact Trane sales to get selectable range for various configurations.

50Pa Motor

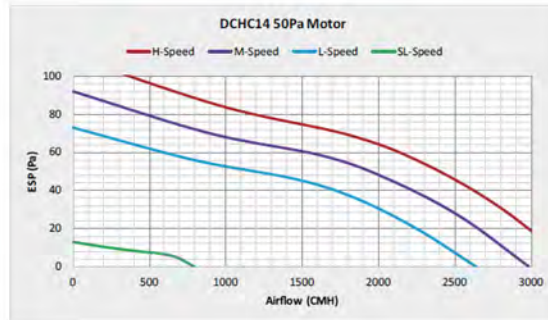
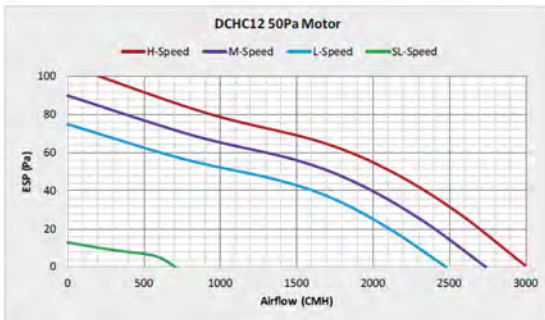
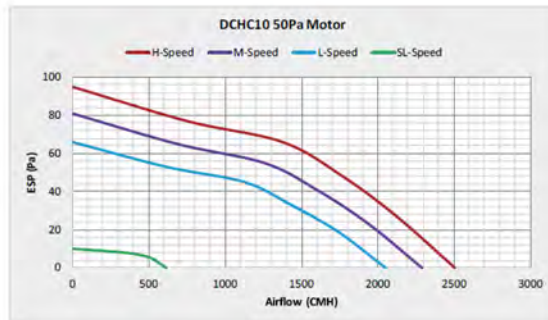
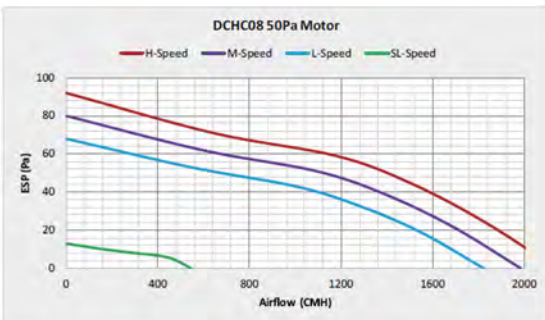
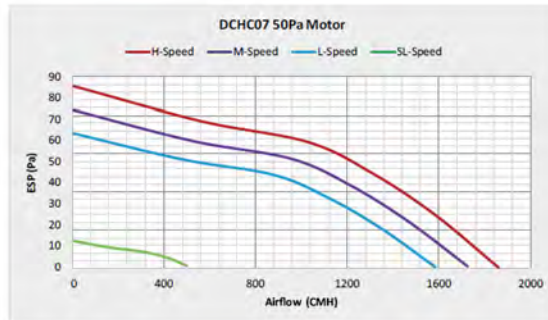
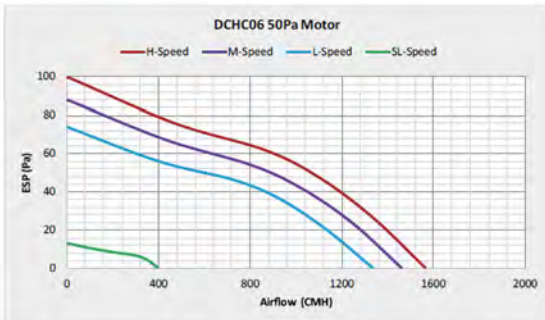
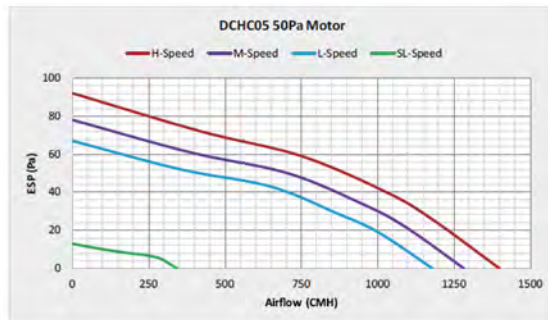
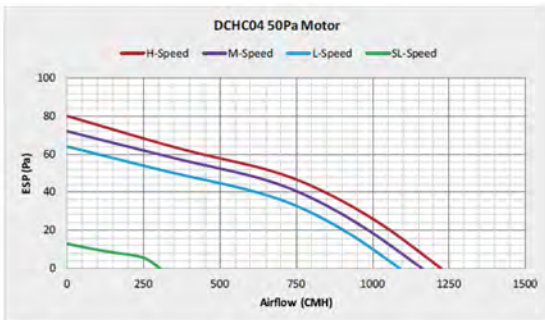
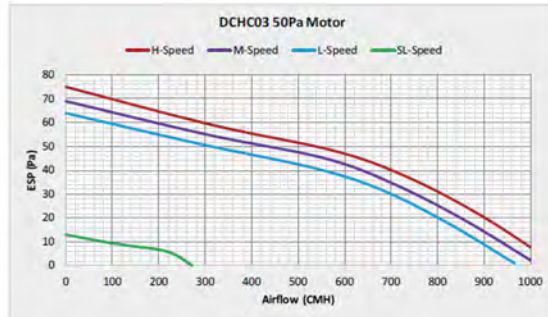
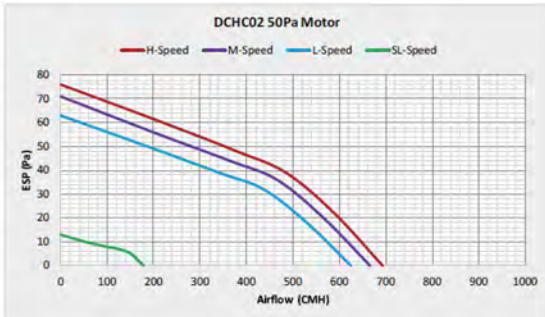
Notes:

1. The airflow curves are based on 3 row coil bare unit (i.e. without return air plenum).
2. Please use Trane TOPSS program or contact Trane sales to get selectable range for various configurations.

HESP 100Pa Motor

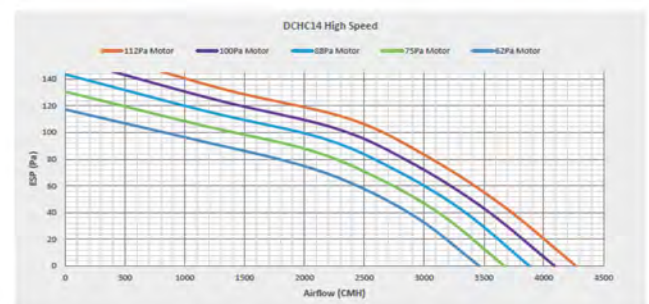
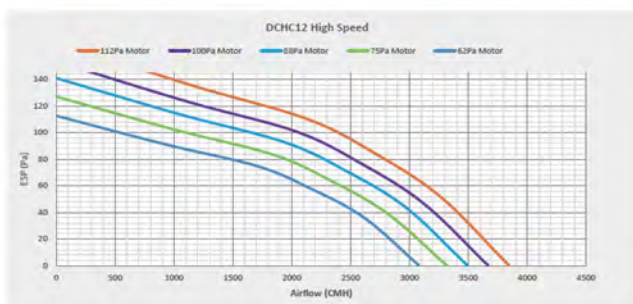
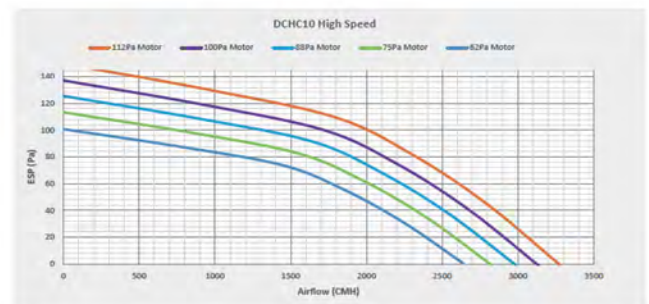
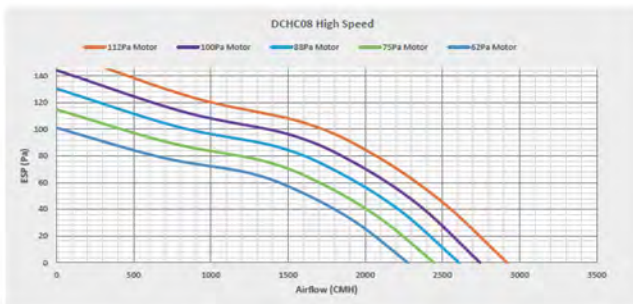
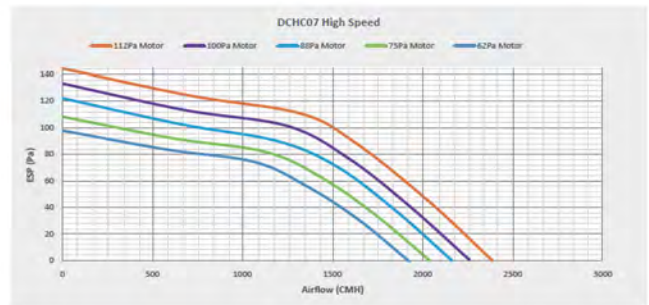
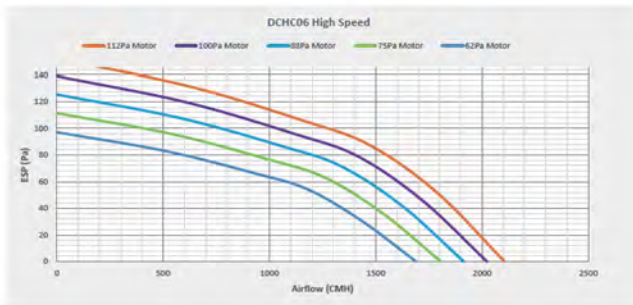
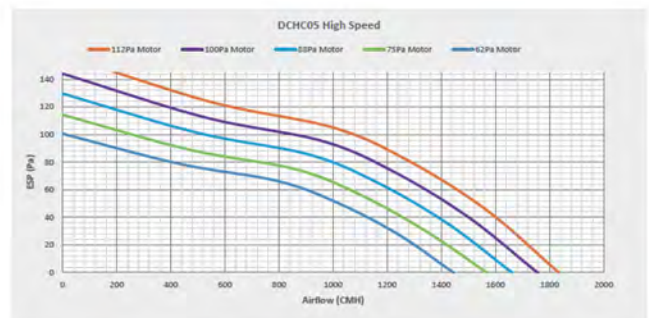
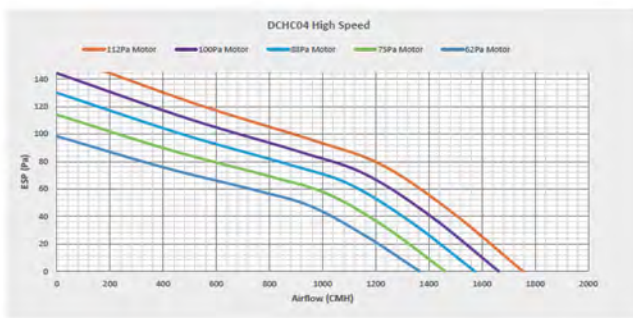
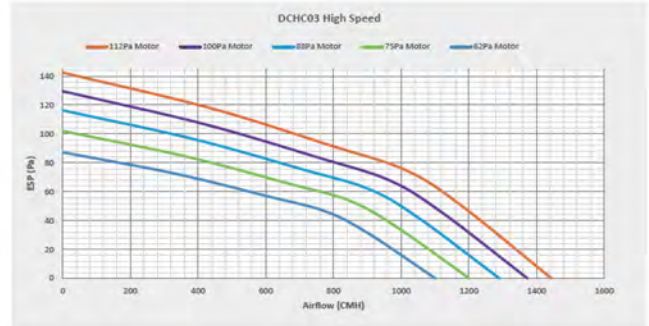
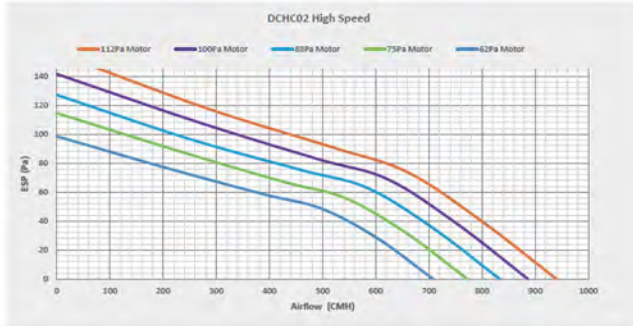

Notes:

1. The airflow curves are based on 3 row coil bare unit (i.e. without return air plenum).
2. Please use Trane TOPSS program or contact Trane sales to get selectable range for various configurations.

Dimensions

Unit without Return Air Plenum

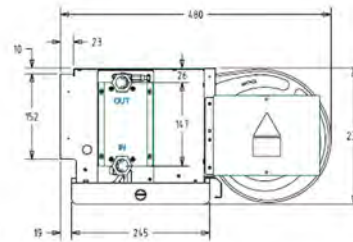
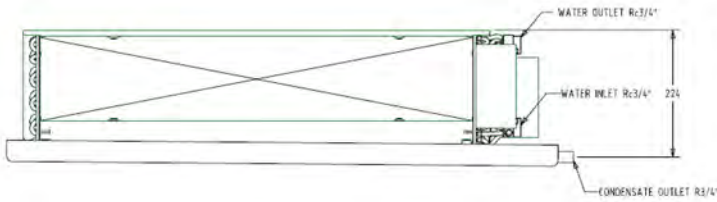
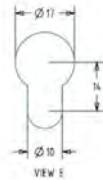
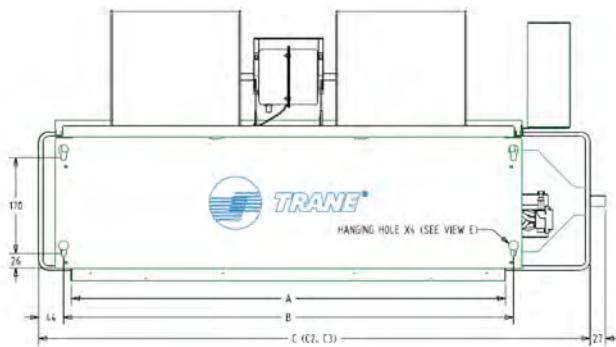
2-Pipe Unit



UNIT MODEL	DIMENSIONS(mm)					MOTOR NO.	FAN NO.
	A	B	C*	C2*	C3*		
DCHC02	440	468	648	848	958	1	1
DCHC03	590	618	798	998	1108	1	2
DCHC04	690	718	898	1098	1208	1	2
DCHC05	770	798	978	1178	1288	1	2
DCHC06	970	998	1183	1383	1493	1	2
DCHC07	1070	1098	1283	1483	1593	2	3
DCHC08	1210	1238	1423	1623	1733	2	3
DCHC10	1330	1358	1543	1743	1853	2	4
DCHC12	1570	1598	1783	1983	2093	2	4
DCHC14	1750	1778	1963	2163	2273	2	4

* C - UNIT WITH STANDARD LENGTH DRAIN PAN.
 C2 - UNIT WITH +200mm EXTENDED LENGTH DRAIN PAN.
 C3 - UNIT WITH +312mm EXTENDED LENGTH DRAIN PAN.

4-Pipe Unit

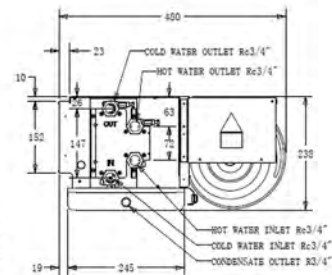
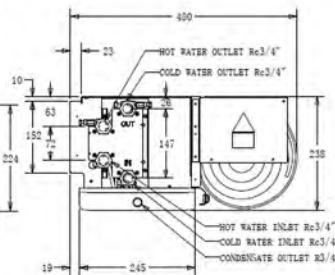
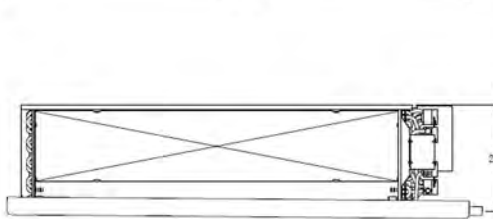
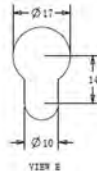
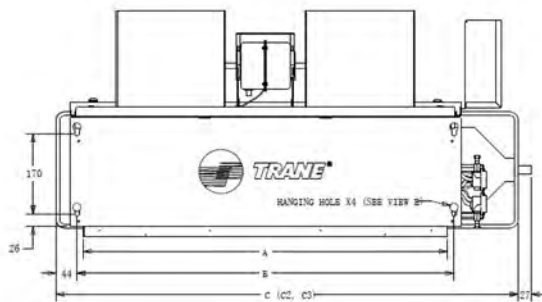

3-1 ROW COIL

2-1 ROW COIL

UNIT MODEL	DIMENSIONS(mm)						MOTOR NO.	FAN NO.
	A	B	C*	C2*	C3*	D		
DCHC02	440	468	648	848	958	526	1	1
DCHC03	590	618	798	998	1108	676	1	2
DCHC04	690	718	898	1098	1208	776	1	2
DCHC05	770	798	978	1178	1288	856	1	2
DCHC06	970	998	1183	1383	1493	1056	1	2
DCHC07	1070	1098	1283	1483	1593	1156	2	3
DCHC08	1210	1238	1423	1623	1733	1296	2	3
DCHC10	1330	1358	1543	1743	1853	1416	2	4
DCHC12	1570	1598	1783	1983	2093	1656	2	4
DCHC14	1750	1778	1963	2163	2273	1836	2	4

* C - UNIT WITH STANDARD LENGTH DRAIN PAN.
 C2 - UNIT WITH +200mm EXTENDED LENGTH DRAIN PAN.
 C3 - UNIT WITH +312mm EXTENDED LENGTH DRAIN PAN.

Unit with Return Air Plenum

Unit with Rear Return Air Plenum

WITH REAR RETURN PLENUM

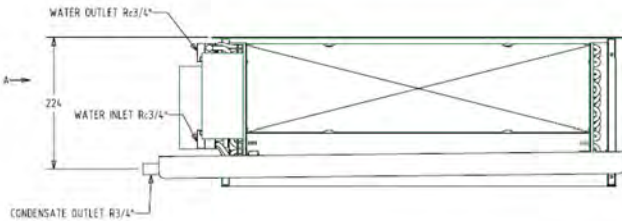
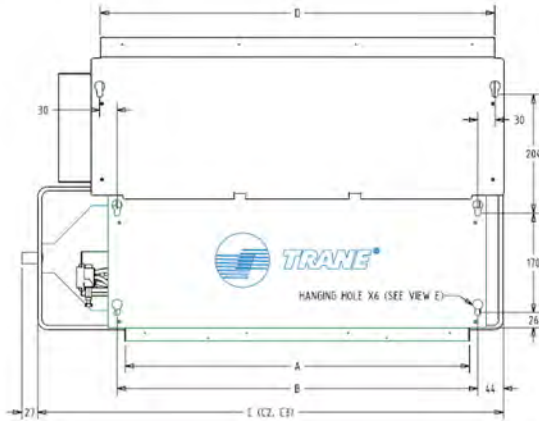

UNIT MODEL	DIMENSIONS(mm)					MOTOR NO.	FAN NO.
	A	B	C*	C2*	C3*		
DCHC02	440	468	648	848	958	1	1
DCHC03	590	618	798	998	1108	1	2
DCHC04	690	718	898	1098	1208	1	2
DCHC05	770	798	978	1178	1288	1	2
DCHC06	970	998	1183	1383	1493	1	2
DCHC07	1070	1098	1283	1483	1593	2	3
DCHC08	1210	1238	1423	1623	1733	2	3
DCHC10	1330	1358	1543	1743	1853	2	4
DCHC12	1570	1598	1783	1983	2093	2	4
DCHC14	1750	1778	1963	2163	2273	2	4



* C - UNIT WITH STANDARD LENGTH DRAIN PAN.
 C2 - UNIT WITH +200mm EXTENDED LENGTH DRAIN PAN.
 C3 - UNIT WITH +310mm EXTENDED LENGTH DRAIN PAN.

VIEW A

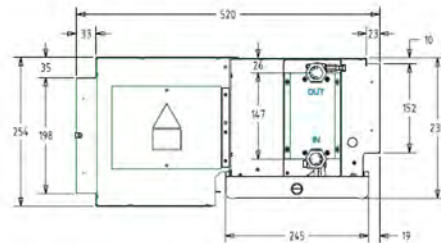

Unit with Bottom Return Air Plenum

WITH BOTTOM RETURN PLENUM

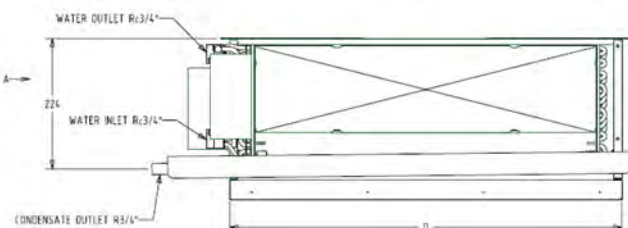
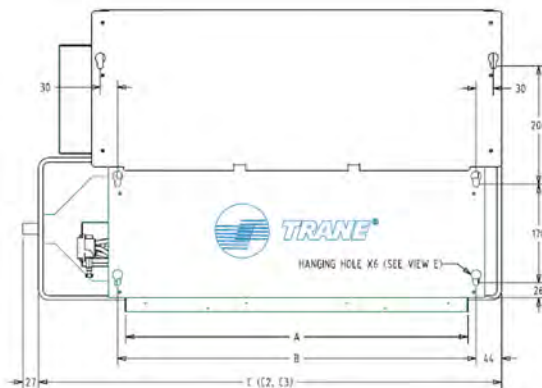

UNIT MODEL	DIMENSIONS(mm)					MOTOR NO.	FAN NO.	
	A	B	C*	C2*	C3*			
DCHC02	440	468	648	848	958	526	1	1
DCHC03	590	618	798	998	1108	676	1	2
DCHC04	690	718	898	1098	1208	776	1	2
DCHC05	770	798	978	1178	1288	856	1	2
DCHC06	970	998	1183	1383	1493	1056	1	2
DCHC07	1070	1098	1283	1483	1593	1156	2	3
DCHC08	1210	1238	1423	1623	1733	1296	2	3
DCHC10	1330	1358	1543	1743	1853	1416	2	4
DCHC12	1570	1598	1783	1983	2093	1656	2	4
DCHC14	1750	1778	1963	2163	2273	1836	2	4

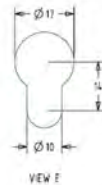

* C - UNIT WITH STANDARD LENGTH DRAIN PAN.
 C2 - UNIT WITH +200mm EXTENDED LENGTH DRAIN PAN.
 C3 - UNIT WITH +310mm EXTENDED LENGTH DRAIN PAN.

VIEW A

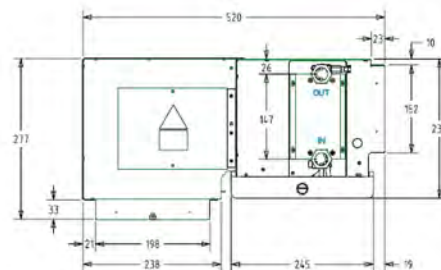

DCHX Unit with Return Air Plenum

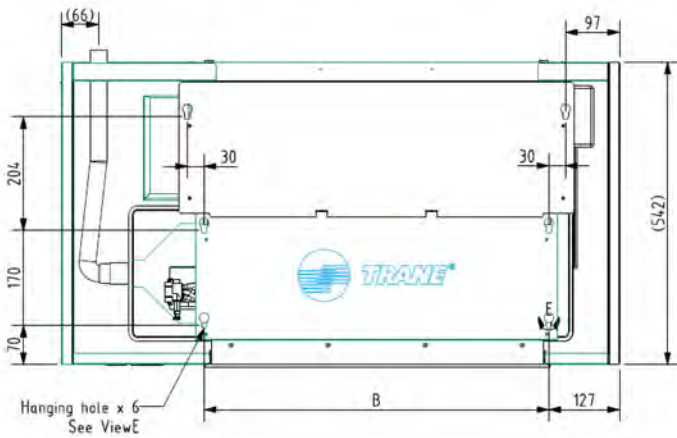

UNIT MODEL	DIMENSIONS(mm)		3ROW Net Weight(Kg)
	A	B	
DCHX02	850	468	25.1
DCHX03	1000	618	29.7
DCHX04	1100	718	32.6
DCHX05	1180	798	34.0
DCHX06	1380	998	39.5
DCHX07	1480	1098	47.6
DCHX08	1620	1238	50.7
DCHX10	1740	1358	56.0
DCHX12	1980	1598	62.1
DCHX14	2160	1778	66.3

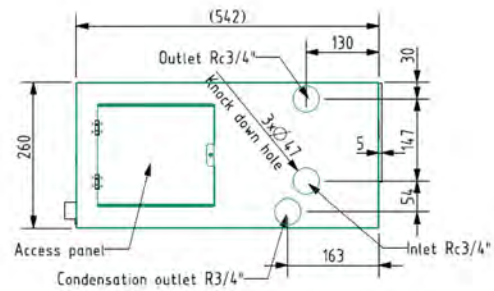
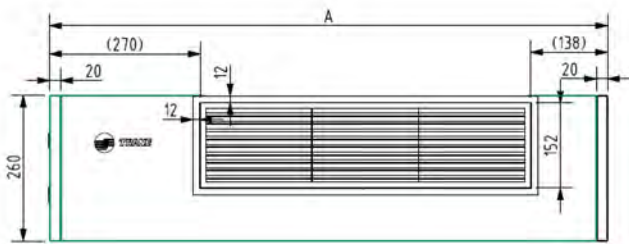
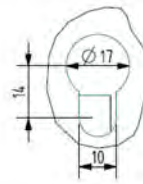

Wiring Diagrams

Unit Wiring Diagram (with DCBL Thermostat)

Single-Motor Unit

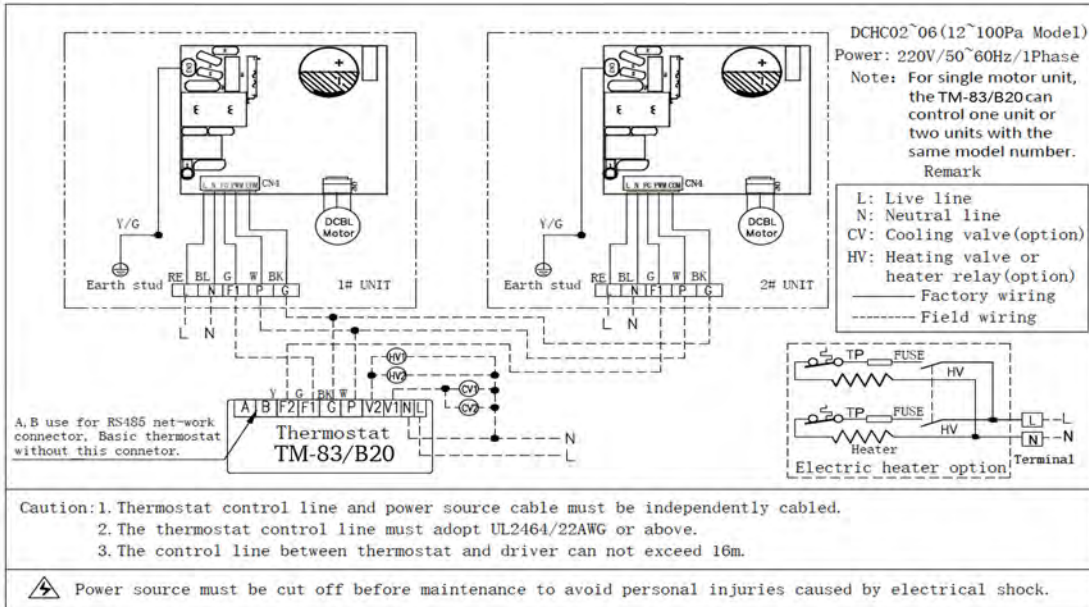

Double-Motor Unit

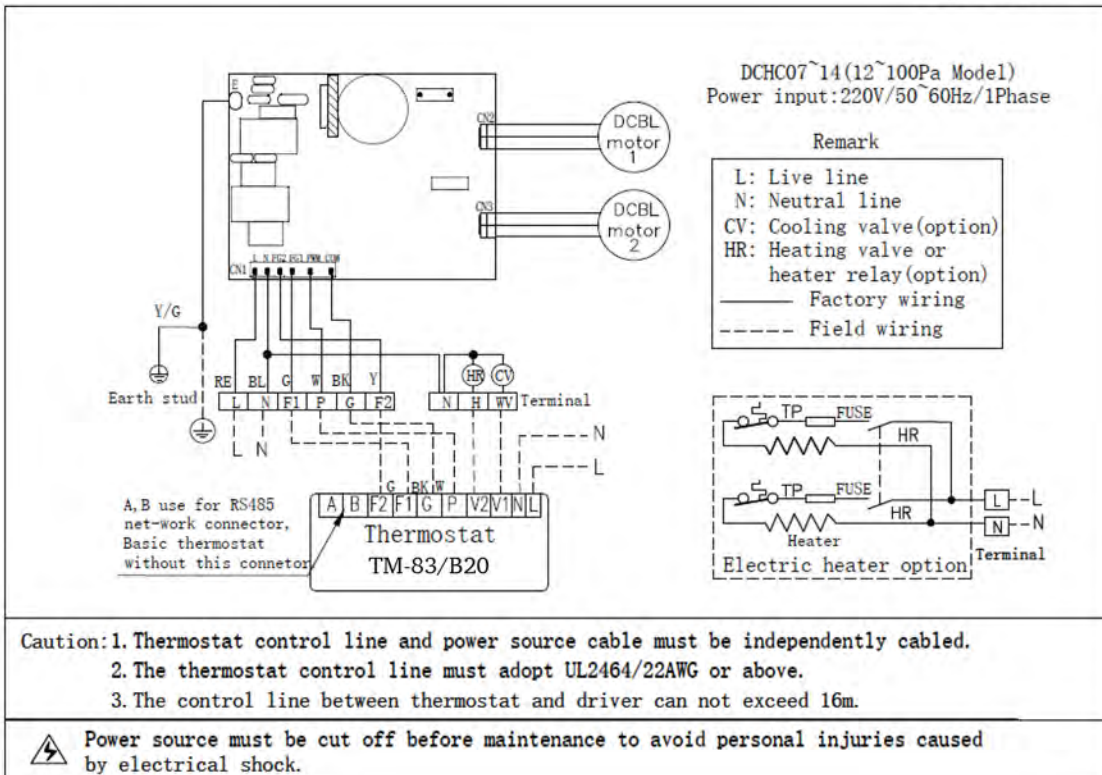

Unit Wiring Diagram (with 3-Speed Module)

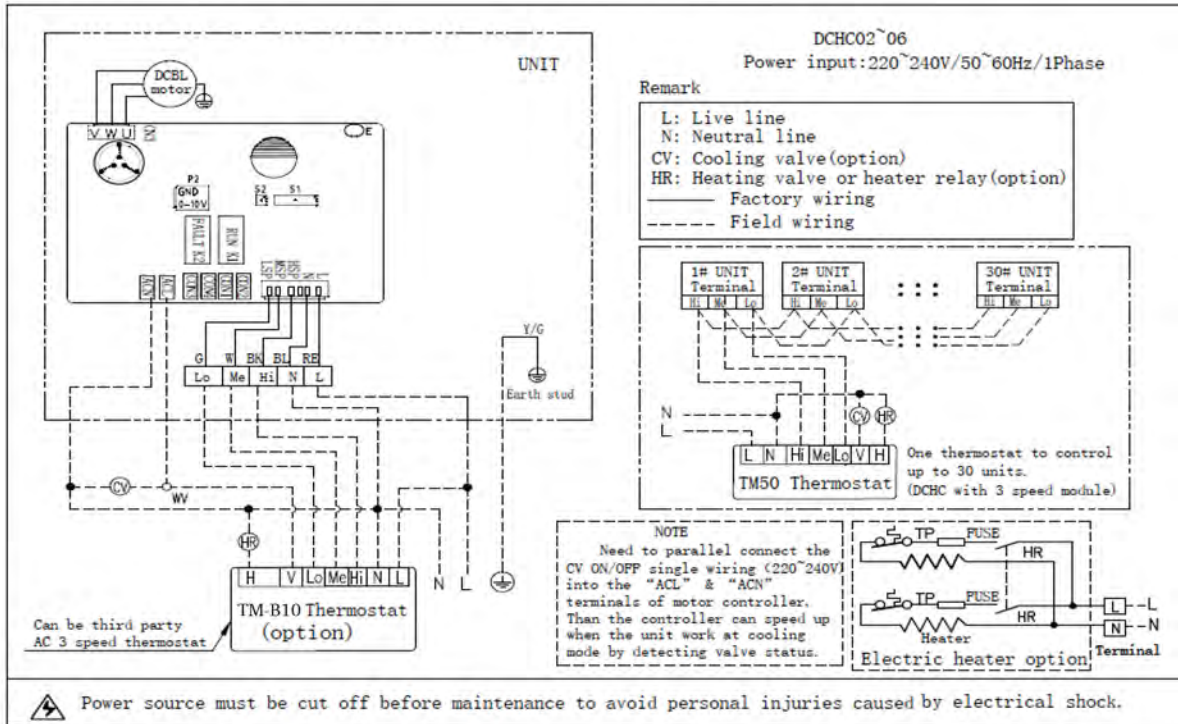

Double-Motor Unit

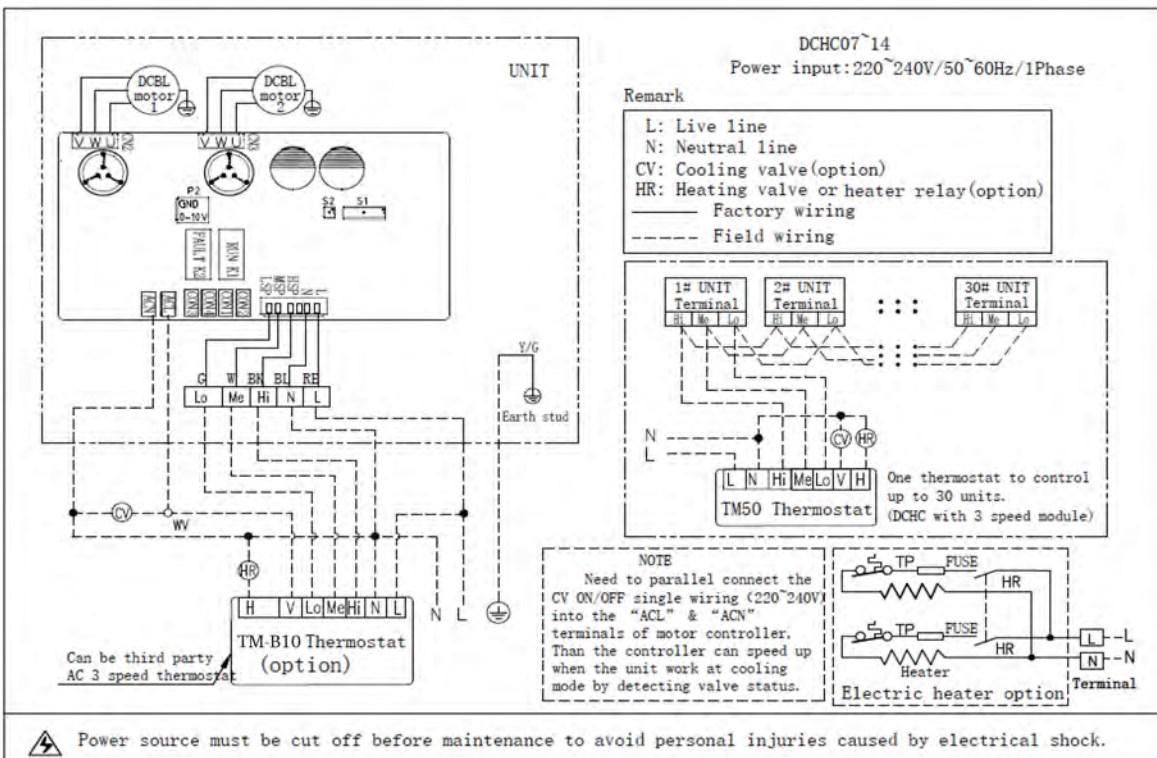

Unit Wiring Diagram (with V-speed modular)

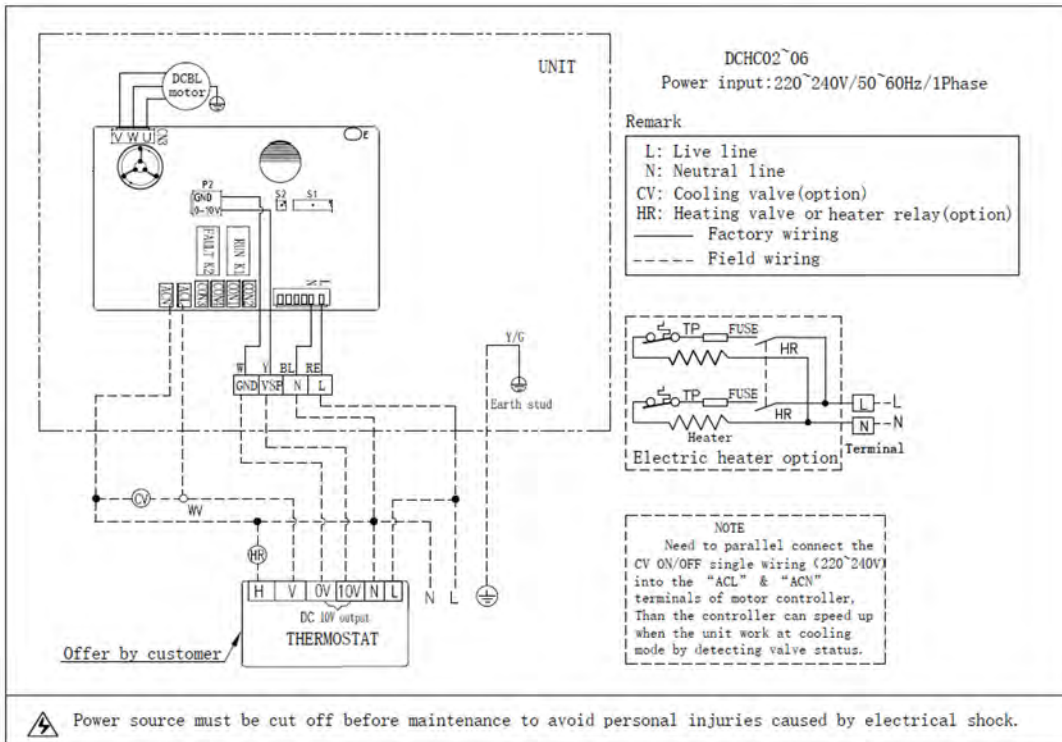

Double unit wiring Diagram

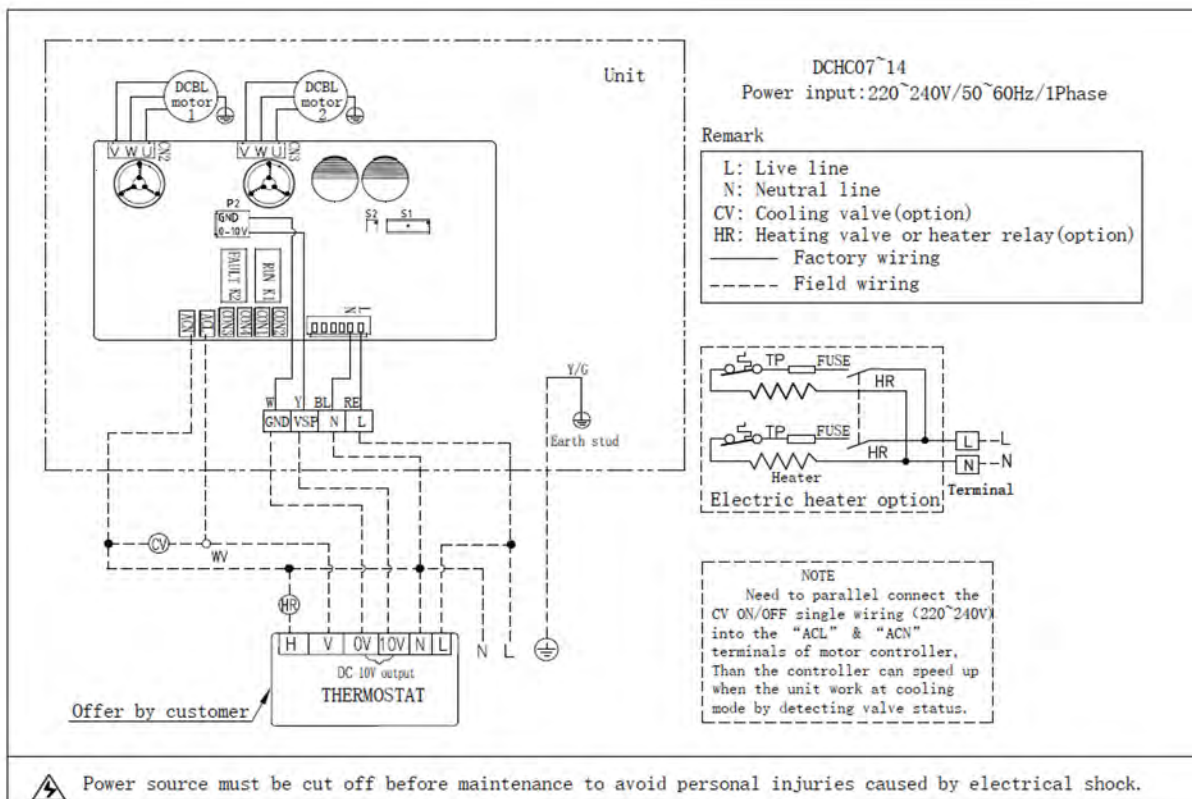

Options

2-Way / 3-Way Valve



Coil Type	Valve Kv	Valve Connection	Nominal Pressure	Close-Off Pressure	Valve On-Off Speed	Power Supply	Power Consumption	IP Grade
2-Pipe Coil, 4-Pipe Coil	2.2	DN20 Female Thread	2.1 MPa	344 kPa	13 ~ 18s (Motor) 4 ~ 5s (Spring)	220 ~ 240VAC	6.5 W	IP51

2-way Valve Package Factory Mounted

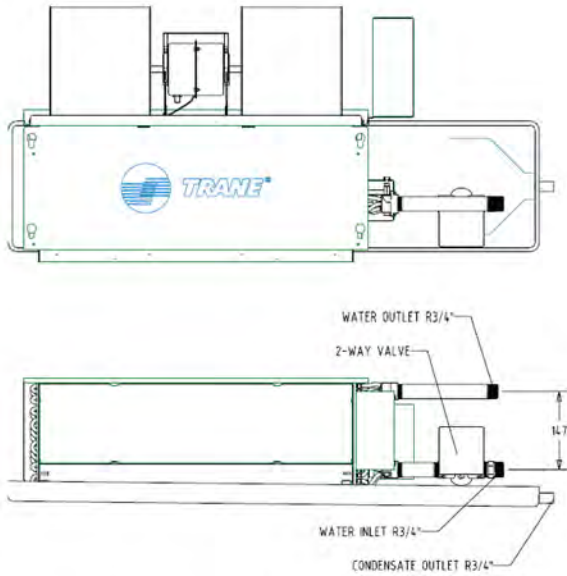

3-way Valve Package Factory Mounted

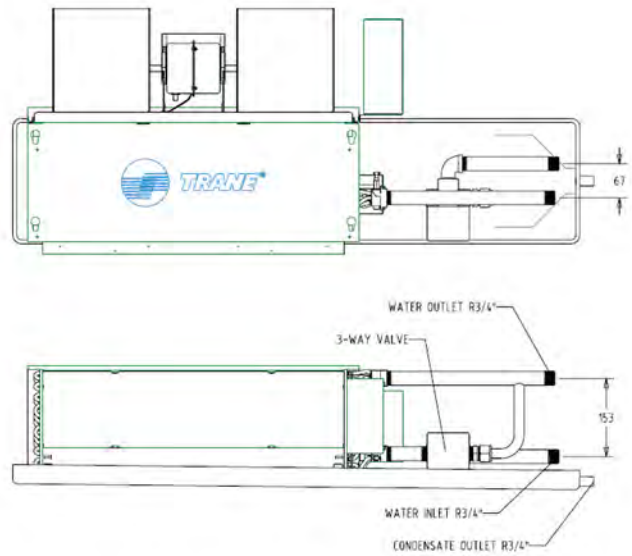

- Notes:**
1. Water valve and piping package are factory mounted. Please select extended drain pan for 2-way valve (+ 200 mm) and 3-way valve (+ 310 mm).
 2. Above valve package drawings are for the units with 2-pipe coils, please contact Trane product support for the units with 4-pipe coils.

Auxiliary Drain Pan

0° Installation

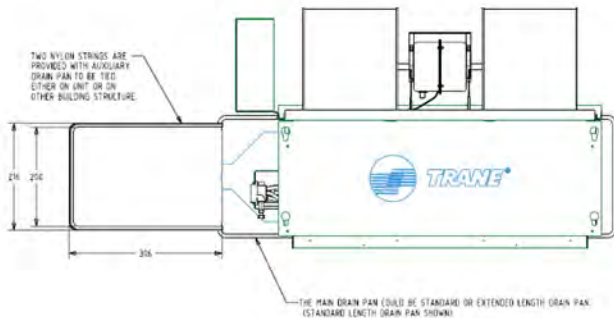

90° Installation

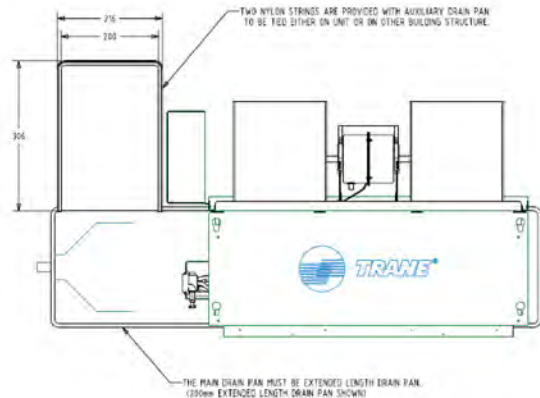



Trane - by Trane Technologies (NYSE: TT), a global climate innovator - creates comfortable, energy efficient indoor environments for commercial and residential applications. For more information, please visit trane.com or tranetechnologies.com.

Trane has a policy of continuous product and product data improvement and reserves the right to change design and specifications without notice. We are committed to using environmentally conscious print practices.